



**Canon**

# *PowerShot G1 X*

## **Camera User Guide**

- Before use, be sure to read this guide, including the safety precautions.
- This guide will familiarize you with how to use the camera correctly.
- Keep the guide handy for future reference.

**ENGLISH**

## Package Contents

Before use, make sure the following items are included in the package. If anything is missing, contact your camera dealer.



Camera



Battery Pack NB-10L  
(with terminal cover)



Battery Charger  
CB-2LC/CB-2LCE

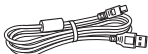

Interface Cable  
IFC-400PCU

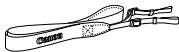

Neck Strap  
NS-DC9



Lens Cap  
(with cord)



Getting Started



DIGITAL CAMERA  
Solution Disk



Warranty Card

- A memory card is not included (see below).

## PDF Manuals

For information about the included software, refer to the *Software Guide*, in PDF format (p. 26).



- Adobe Reader is required to view the PDF manuals.

## Compatible Memory Cards

The following memory cards (sold separately) can be used, regardless of capacity.

- SD memory cards\*
- SDHC memory cards\*
- SDXC memory cards\* 
- Eye-Fi cards

\* Conforms to SD specifications. However, not all memory cards have been verified to work with the camera.

## About Eye-Fi Cards

This product is not guaranteed to support Eye-Fi card functions (including wireless transfer). In case of an issue with an Eye-Fi card, please check with the card manufacturer.

Also note that an approval is required to use Eye-Fi cards in many countries or regions. Without approval, use of the card is not permitted. If it is unclear whether the card has been approved for use in the area, please check with the card manufacturer.



- Always confirm beforehand that memory cards are supported on other devices such as card readers and computers (including the current version of your operating system).

## Preliminary Notes and Legal Information

- Take and review some test shots initially to make sure the images were recorded correctly. Please note that Canon Inc., its subsidiaries and affiliates, and its distributors are not liable for any consequential damages arising from any malfunction of a camera or accessory, including memory cards, that results in the failure of an image to be recorded or to be recorded in a way that is machine readable.
- Images recorded by the camera are intended for personal use. Refrain from unauthorized recording that infringes on copyright law, and note that even for personal use, photography may contravene copyright or other legal rights at some performances or exhibitions, or in some commercial settings.
- The camera warranty is valid only in the area of purchase. In case of camera problems while abroad, return to the area of purchase before contacting a Canon Customer Support Help Desk.
- Although the LCD monitor is produced under extremely high-precision manufacturing conditions and more than 99.99% of the pixels meet design specifications, in rare cases some pixels may be defective or may appear as red or black dots. This does not indicate camera damage or affect recorded images.
- The LCD monitor may be covered with a thin plastic film for protection against scratches during shipment. If covered, remove the film before using the camera.
- When the camera is used over an extended period, it may become warm. This does not indicate damage.

# Part Names and Conventions in This Guide

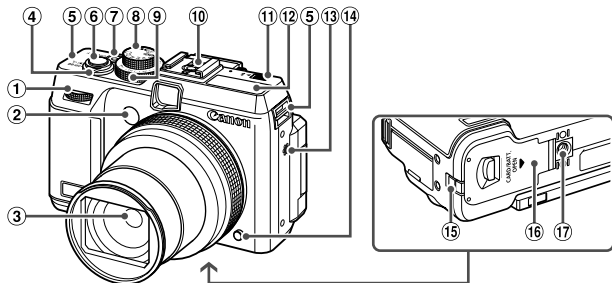

- |                                 |                              |
|---------------------------------|------------------------------|
| ① Front dial                    | ⑧ Mode dial                  |
| ② Lamp                          | ⑨ Exposure compensation dial |
| ③ Lens                          | ⑩ Hot shoe                   |
| ④ Zoom lever                    | ⑪  (Pop up flash) switch     |
| Shooting:  (telephoto) /        | ⑫ Flash                      |
| (wide angle)                    | ⑬ Speaker                    |
| Playback:  (magnify) /  (index) | ⑭ Ring release button        |
| ⑤ Strap mount                   | ⑮ DC coupler cable port      |
| ⑥ Shutter button                | ⑯ Memory card/battery cover  |
| ⑦ Power button/lamp             | ⑰ Tripod socket              |

- In this guide, icons are used to represent the corresponding camera buttons and dials on which they appear or which they resemble.
- The following camera buttons and controls are represented by icons.
  - Front dial ① on front
  - Up button ⑯ on back
  - Left button ⑰ on back
  - Control dial ⑱ on back
  - FUNC./SET button ⑲ on back
  - Right button ⑳ on back
  - Down button ㉑ on back
- On-screen text is indicated in brackets.
- : Important information you should know
- : Notes and tips for expert camera use
- (p. xx): Pages with related information (in this example, “xx” represents a page number)
- Instructions in this guide apply to the camera under default settings.

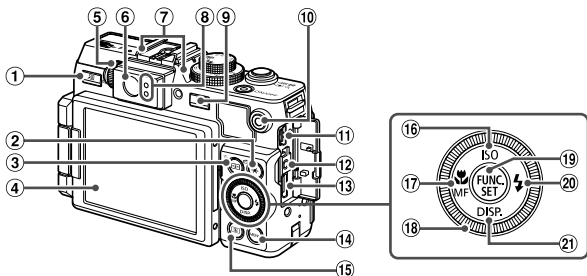

- |   |  |
|---|--|
| ①  (Shortcut) /  (Direct print) button                | ⑫ Remote terminal                            |
| ②  (AE lock/FE lock) /  (Jump) button                 | ⑬ HDMI™ terminal                             |
| ③  (AF Frame Selector) /  (Single image erase) button | ⑭ MENU button                                |
| ④ Screen (LCD monitor)                                | ⑮  (Metering) button                         |
| ⑤ Diopter adjustment dial                             | ⑯ ISO speed / Up button                      |
| ⑥ Viewfinder  | ⑰  (Macro) / MF (Manual focus) / Left button |
| ⑦ Microphone  | ⑱ Control dial                               |
| ⑧ Indicator   | ⑲ FUNC./SET button                           |
| ⑨  (Playback) button                                  | ⑳  (Flash) / Right button                    |
| ⑩ Movie button  | ㉑ DISP. (Display) / Down button              |
| ⑪ AV OUT (Audio/video output) / DIGITAL terminal      |  |



- Turning the control dial is one way to choose setting items, switch images, and perform other operations. Most of these operations are also possible with the buttons.

- For convenience, all supported memory cards are simply referred to as “the memory card” .
- The tabs shown above titles indicate whether the function is used for still images, movies, or both.

**Still Images** : Indicates that the function is used when shooting or viewing still images.

**Movies** : Indicates that the function is used when shooting or viewing movies.

# Contents

Package Contents .....	2	Special Modes for Other Purposes .....	81
Compatible Memory Cards .....	2	Shooting Various Movies .....	88
Preliminary Notes and Legal Information .....	3		
Part Names and Conventions in This Guide .....	4		
Contents .....	6	<b>4 P mode .....</b>	<b>91</b>
Contents: Basic Operations .....	8	Shooting in Program AE Mode (P Mode) .....	92
Safety Precautions .....	10	Image Brightness (Exposure Compensation) .....	93
Initial Preparations .....	13	Color and Continuous Shooting ...	100
Trying the Camera Out .....	21	Shooting Range and Focusing .....	105
Included Software, PDF Manuals .....	26	Flash .....	116
Accessories .....	32	Shooting RAW Images .....	119
		Other Settings .....	120
<b>1 Camera Basics .....</b>	<b>35</b>		
On/Off .....	36	<b>5 Tv, Av, M, C1, C2 Mode..</b>	<b>123</b>
Shutter Button .....	37	Specific Shutter Speeds (Tv Mode) .....	124
Optical Viewfinder .....	38	Specific Aperture Values (Av Mode) .....	125
Shooting Modes .....	39	Specific Shutter Speeds and Aperture Values (M Mode) .....	126
Shooting Display Options .....	39	Customization for Shooting Styles .....	128
FUNC. Menu .....	40		
<b>MENU Menu .....</b>	<b>41</b>		
Indicator Display .....	42		
Clock .....	42		
<b>2 Smart Auto Mode .....</b>	<b>43</b>		
Shooting in Smart Auto Mode .....	44	<b>6 Playback Mode .....</b>	<b>135</b>
Common, Convenient Features .....	51	Viewing .....	136
Image Customization Features .....	56	Browsing and Filtering Images .....	141
Helpful Shooting Features .....	62	Image Viewing Options .....	145
Customizing Camera Operation .....	65	Protecting Images .....	148
		Erasing Images .....	152
		Rotating Images .....	155
		Image Categories .....	157
		Editing Still Images .....	160
		Editing Movies .....	165
<b>3 Other Shooting Modes.....</b>	<b>67</b>		
Specific Scenes .....	68		
Image Effects (Creative Filters) .....	71		

---

<b>7 Setting Menu .....</b>	<b>167</b>
Adjusting Basic Camera	
Functions .....	168

---

<b>8 Accessories .....</b>	<b>181</b>
Tips on Using Included	
Accessories .....	182
Optional Accessories .....	182
Using Optional Accessories .....	186

---

Printing Images .....	202
Using an Eye-Fi Card .....	212

---

<b>9 Appendix .....</b>	<b>215</b>
Troubleshooting .....	216
On-Screen Messages .....	220
On-Screen Information .....	222
Functions and Menu Tables .....	226
Handling Precautions .....	236
Index .....	237

# Contents: Basic Operations



## Shoot

- Use camera-determined settings (Auto Mode) ..... 44

### Shooting people well



Portraits  
(p. 68)



Kids and Pets  
(p. 68)



At the Beach  
(p. 69)



Against Snow  
(p. 70)

### Matching specific scenes



Landscape  
(p. 68)



Sports  
(p. 69)



Night Scenes  
(p. 69)



Under Water  
(p. 69)



Foliage  
(p. 70)



Fireworks  
(p. 70)

### Applying special effects



Vivid Colors  
(p. 71)



Poster Effect  
(p. 71)



"Aged" Photos  
(p. 73)



Fish-Eye Effect  
(p. 74)



Miniature Effect  
(p. 74)



Toy Camera Effect  
(p. 76)



Monochrome  
(p. 77)

- Focus on faces ..... 44, 68, 108, 113
- Without using the flash (Flash Off) ..... 22, 45
- With myself in the shot (Self-Timer)..... 52, 84
- Add the shooting date and time (Date Stamp)..... 54
- Movie clips and photos together (Movie Digest)..... 81



**View**

- View images (Playback Mode) ..... 136
- Automatic playback (Slideshow)..... 146
- On a TV ..... 186
- On a computer..... 26
- Browse through images quickly ..... 141
- Erase images..... 152

**Shoot/View Movies**

- Shoot movies ..... 44, 88
- View movies ..... 136

**Print**

- Print pictures..... 202

**Save**

- Save images to a computer..... 29

# Safety Precautions

- Before using the product, please ensure that you read the safety precautions described below. Always ensure that the product is used correctly.
- The safety precautions noted on the following pages are intended to prevent injuries to yourself and other persons, or damage to the equipment.
- Be sure to also check the guides included with any separately sold accessories you use.



## Warning

Denotes the possibility of serious injury or death.

- **Do not trigger the flash in close proximity to people's eyes.**

Exposure to the intense light produced by the flash could damage eyesight. In particular, remain at least one meter (39 inches) away from infants when using the flash.

- **Store this equipment out of the reach of children and infants.**

Strap: Putting the strap around a child's neck could result in asphyxiation.

- **Use only recommended power sources.**
- **Do not attempt to disassemble, alter or apply heat to the product.**
- **Avoid dropping or subjecting the product to severe impacts.**
- **To avoid the risk of injury, do not touch the interior of the product if it has been dropped or otherwise damaged.**
- **Stop using the product immediately if it emits smoke, a strange smell, or otherwise behaves abnormally.**
- **Do not use organic solvents such as alcohol, benzene, or thinner to clean the product.**
- **Do not let the product come into contact with water (e.g. sea water) or other liquids.**
- **Do not allow liquids or foreign objects to enter the camera.**

This could result in electrical shock or fire.

If liquids or foreign objects come into contact with the camera interior, immediately turn the camera off and remove the battery.

If the battery charger becomes wet, unplug it from the outlet and consult your camera distributor or a Canon Customer Support Help Desk.

- **Do not look through the viewfinder at bright light sources (such as the sun on a clear day).**

This could damage your eyesight.

- **Use only the recommended battery.**
- **Do not place the battery near or in direct flame.**
- **Unplug the power cord periodically, and using a dry cloth, wipe away any dust and dirt that has collected on the plug, the exterior of the power outlet, and the surrounding area.**
- **Do not handle the power cord with wet hands.**
- **Do not use the equipment in a manner that exceeds the rated capacity of the electrical outlet or wiring accessories. Do not use if the power cord or plug are damaged, or not fully plugged into the outlet.**
- **Do not allow dirt or metal objects (such as pins or keys) to contact the terminals or plug.**

The battery may explode or leak, resulting in electrical shock or fire. This could cause injury and damage the surroundings. In the event that a battery leaks and the battery electrolyte contacts eyes, mouth, skin or clothing, immediately flush with water.

- **Turn the camera off in places where camera use is prohibited.**

The electromagnetic waves emitted by the camera may interfere with the operation of electronic instruments and other devices. Exercise adequate caution when using the camera in places where use of electronic devices is restricted, such as inside airplanes and medical facilities.

- **Do not play the supplied CD-ROM(s) in any CD player that does not support data CD-ROMs.**

It is possible to suffer hearing loss from listening with headphones to the loud sounds of a CD-ROM played on an audio CD player (music player). Additionally, this could damage the speakers.



## Caution

**Denotes the possibility of injury.**

- **When holding the camera by the strap, be careful not to bang it, subject it to strong impacts or shocks, or let it get caught on other objects.**
- **Be careful not to bump or push strongly on the lens.**

This could lead to injury or damage the camera.

- **When using the flash, be careful not to cover it with your fingers or clothing.**

This could result in burns or damage to the flash.

- **Avoid using, placing or storing the product in the following places:**

- Places subject to strong sunlight
- Places subject to temperatures above 40 °C (104 °F)
- Humid or dusty areas

These could cause leakage, overheating or an explosion of the battery, resulting in electrical shock, fire, burns or other injuries.

High temperatures may cause deformation of the camera or battery charger casing.

- **Viewing images on the camera screen for prolonged periods may cause discomfort.**

## Caution

**Denotes the possibility of damage to the equipment.**

- **Do not aim the camera at bright light sources (such as the sun on a clear day).** Doing so may damage the image sensor.

- **When using the camera on a beach or at a windy location, be careful not to allow dust or sand to enter the camera.**

This may cause the product to malfunction.

## Safety Precautions

- **In regular use, small amounts of smoke may be emitted from the flash.**

This is due to the high intensity of the flash burning dust and foreign materials stuck to the front of the unit. Please use a cotton swab to remove dirt, dust or other foreign matter from the flash to prevent heat build-up and damage to the unit.

- 
- **Remove and store the battery when you are not using the camera.**

If the battery is left inside the camera, damage caused by leakage may occur.

- 
- **Before you discard the battery, cover the terminals with tape or other insulators.**

Contacting other metal materials may lead to fire or explosions.

- 
- **Unplug the battery charger from the power outlet after charging is complete, or when you are not using it.**

- **Do not place anything, such as cloth, on top of the battery charger while it is charging.**

Leaving the unit plugged in for a long period of time may cause it to overheat and distort, resulting in fire.

- 
- **Do not place the battery near pets.**

Pets biting the battery could cause leakage, overheating or explosion, resulting in fire or damage.

- 
- **When putting the camera in your bag, close the screen to face inward to ensure that hard objects do not come into contact with the screen.**

- **Do not attach any hard objects to the camera.**

Doing so may cause malfunctions or damage the screen.

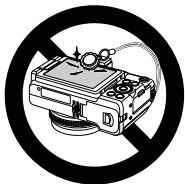

# Initial Preparations

Prepare for shooting as follows.

## Attaching Accessories

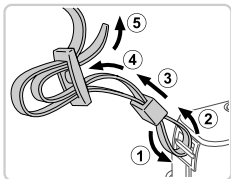

### 1 Attach the strap.

- Attach the included strap to the camera as shown.
- On the other side of the camera, attach the strap the same way.

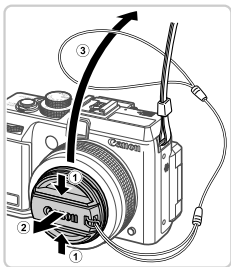

### 2 Attach the lens cap to the strap.

- Remove the lens cap from the lens and attach the lens cap cord to the strap.
- Always remove the lens cap before turning the camera on. Try attaching the lens cap to the neck strap when the cap is not in use.
- Keep the lens cap on the lens when the camera is not in use.

## Holding the Camera



- Place the strap around your neck.
- When shooting, keep your arms close to your body and hold the camera securely to prevent it from moving. If you have raised the flash, do not rest your fingers on it.

## Charging the Battery

Before use, charge the battery with the included charger. Be sure to charge the battery initially, because the camera is not sold with the battery charged.

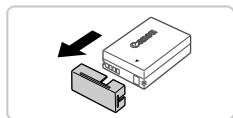

### 1 Remove the cover.

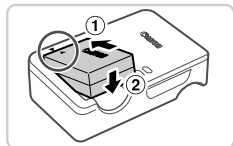

### 2 Insert the battery.

- After aligning the ▲ marks on the battery and charger, insert the battery by pushing it in (①) and down (②).

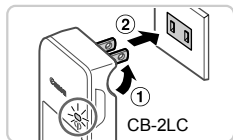

### 3 Charge the battery.

- **For CB-2LC:** Flip out the plug (①) and plug the charger into a power outlet (②).
- **For CB-2LCE:** Plug the power cord into the charger, then plug the other end into a power outlet.

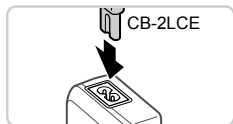

- ▶ The charging lamp turns orange and charging begins.
- ▶ When the charging is finished, the lamp turns green.

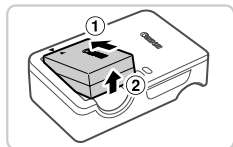

### 4 Remove the battery.

- After unplugging the battery charger, remove the battery by pushing it in (①) and up (②).

- ❗ To protect the battery and keep it in optimal condition, do not charge it continuously for more than 24 hours.
- For battery chargers that use a power cord, do not attach the charger or cord to other objects. Doing so could result in malfunction or damage to the product.



- For details on charging time and the number of shots and recording time possible with a fully charged battery, see “Specifications” in the *Getting Started* guide.

## Inserting the Battery and Memory Card

Insert the included battery and a memory card (sold separately). Note that before using a new memory card (or a memory card formatted in another device), you should format the memory card with this camera (p. 171).

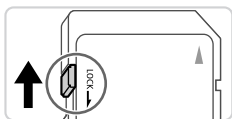

### 1 Check the card's write-protect tab.

- Recording is not possible on memory cards with a write-protect tab when the tab is in the locked (downward) position. Slide the tab up until it clicks into the unlocked position.

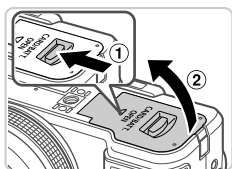

### 2 Open the cover.

- Slide the switch (①) and open the cover (②).

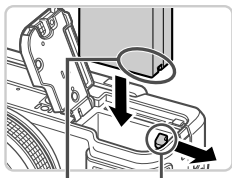

### 3 Insert the battery.

- While pressing the battery lock in the direction of the arrow, insert the battery facing as shown and push it in until it clicks into the locked position.

Terminals      Battery Lock

- If you insert the battery facing the wrong way, cannot be locked into the correct position. Always confirm that the battery is facing the right way and locks when inserted.

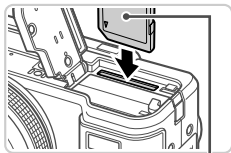

Label

### 4 Insert the memory card.

- Insert the memory card facing as shown until it clicks into the locked position.
- Make sure the memory card is facing the right way when you insert it. Inserting memory cards facing the wrong way may damage the camera.

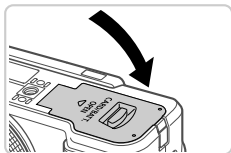

### 5 Close the cover.

- Lower the cover in the direction of the arrow and press it until it clicks into the closed position.

## Removing the Battery and Memory Card

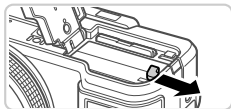

### Remove the battery.

- Open the cover and press the battery lock in the direction of the arrow.
- ▶ The battery will pop up.

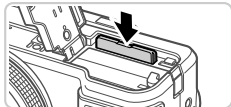

### Remove the memory card.

- Push the memory card in until it clicks, and then slowly release it.
- ▶ The memory card will pop up.



## Using the Screen

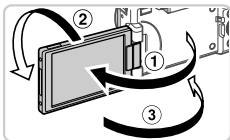

### Prepare the screen for use.

- Open the screen (①) and rotate it toward the lens 180° (②).
- Close the screen in this orientation (③).

- ! • The screen can only open to approximately 175° in direction ①. Be careful not to open the screen any further than this, as it will damage the camera.

### Adjusting the Screen Angle and Orientation

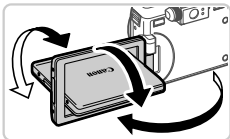

- You can adjust the angle and orientation of the screen as needed, to suit shooting conditions.
- To protect the screen when the camera is not in use, always keep it closed and facing the camera body.

- ! • If the screen is closed and facing the camera body, you will not be able to shoot a movie.



- When including yourself in shots, you can view a mirror image of yourself by rotating the screen around toward the front of the camera. To cancel reverse display, press the **MENU** button, choose [Reverse Disp.] on the tab, and press the buttons to choose [Off].

## Setting the Date and Time

A screen for setting the date and time is displayed the first time you turn the camera on. Be sure to specify the date and time, which is the basis for dates and times added to your images.

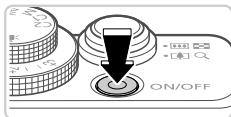

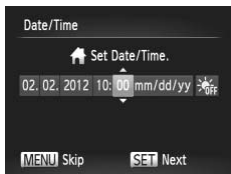

### 1 Turn the camera on.

- Press the power button.
- ▶ The [Date/Time] screen is displayed.



### 2 Set the date and time.

- Press the ◀▶ buttons to choose an option.
- Press the ▲▼ buttons or turn the  dial to specify the date and time.
- When finished, press the  button.

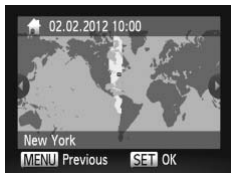

### 3 Set the local time zone.





- Press the ◀▶ buttons or turn the  dial to choose your local time zone.



### 4 Finish the setup process.

- Press the  button when finished. After a confirmation message, the setting screen is no longer displayed.
- To turn off the camera, press the power button.

- ⓘ Unless you set the date, time, and local time zone, the [Date/Time] screen will be displayed each time you turn the camera on. Specify the correct information.

-  To set daylight saving time (1 hour ahead), choose  in step 2 and then choose  by pressing the  buttons or turning the  dial.

## Changing the Date and Time

Adjust the date and time as follows.

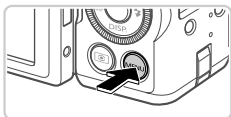



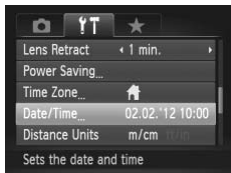

### 1 Access the camera menu.

- Press the **MENU** button.





### 2 Choose [Date/Time].

- Move the zoom lever to choose the  tab.
- Press the  buttons or turn the  dial to choose [Date/Time], and then press the  button.

### 3 Change the date and time.

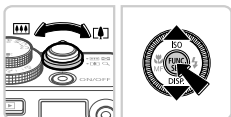
- Follow step 2 on p. 18 to adjust the settings.
- Press the **MENU** button to close the menu.



-  Date/time settings can be retained for about 3 weeks by the camera's built-in date/time battery (backup battery) after the battery pack is removed.
- The date/time battery will be charged in about 4 hours once you insert a charged battery or connect the camera to an AC adapter kit (sold separately, p. 182), even if the camera is left off.
- Once the date/time battery is depleted, the [Date/Time] screen will be displayed when you turn the camera on. Follow the steps on p. 18 to set the date and time.

## Display Language

The display language can be changed as needed.

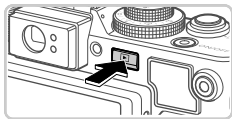

### 1 Enter Playback mode.

- Press the  button.









### 2 Access the setting screen.



- Press and hold the  button, and then immediately press the **MENU** button.



### 3 Set the display language.

- Press the     buttons or turn the  dial to choose a language, and then press the  button.
- ▶ Once the display language has been set, the setting screen is no longer displayed.



- A clock icon is displayed if you wait too long in step 2 after pressing the  button before you press the **MENU** button. In this case, press the  button to dismiss the clock icon and repeat step 2.
- You can also change the display language by pressing the **MENU** button and choosing [Language  tab.

# Trying the Camera Out

Follow these instructions to turn the camera on, shoot still images or movies, and then view them.

## Shooting (Smart Auto)

For fully automatic selection of the optimal settings for specific scenes, simply let the camera determine the subject and shooting conditions.

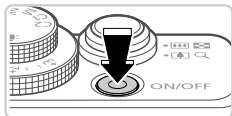

### 1 Turn the camera on.

- Press the power button.
- ▶ The startup screen is displayed.

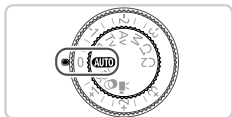

### 2 Enter **AUTO** mode.

- Set the mode dial to **AUTO**.
- Aim the camera at the subject. As the camera determines the scene, it will make a slight clicking noise.
- ▶ Icons representing the scene and image stabilization mode are displayed in the upper right of the screen.
- ▶ Frames displayed around any subjects that are detected indicate that they are in focus.



### 3 Compose the shot.

- To zoom in and enlarge the subject, move the zoom lever toward [📷] (telephoto), and to zoom away from the subject, move it toward [▮▮▮] (wide angle).

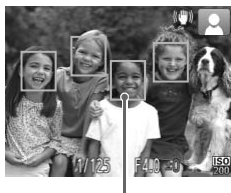
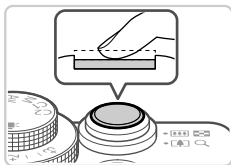

AF Frames

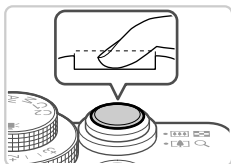
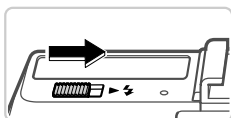

#### 4 Shoot.

### Shooting Still Images

#### ① Focus.

- Press the shutter button lightly, halfway down. The camera beeps twice after focusing, and AF frames are displayed to indicate image areas in focus.

- If [Raise the flash] appears on the screen, move the switch to raise the flash. It will fire when shooting. If you prefer not to use the flash, push it down with your finger, into the camera.

#### ② Shoot.

- Press the shutter button all the way down.
- ▶ As the camera shoots, a shutter sound is played, and in low-light conditions when you have raised the flash, it fires automatically.
- ▶ Your shot remains displayed on the screen for about two seconds.
- Even while the shot is displayed, you can take another shot by pressing the shutter button again.



Elapsed Time



## Shooting Movies

### ① Start shooting.

- If the flash is already up, push it down with your finger, into the camera.
- Press the movie button. The camera beeps once as recording begins, and [●Rec] is displayed with the elapsed time.
- ▶ Black bars displayed on the top and bottom edges of the screen indicate image areas not recorded.
- Once recording begins, you can take your finger off the movie button.

### ② Finish shooting.

- Press the movie button again to stop shooting. The camera beeps twice as recording stops.
- ▶ Recording will stop automatically when the memory card becomes full.

## Viewing

After shooting images or movies, you can view them on the screen as follows.

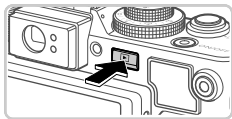





### 1 Enter Playback mode.





- Press the  button.
- ▶ Your last shot is displayed.



### 2 Browse through your images.

- To view the previous image, press the  button or turn the  dial counterclockwise. To view the next image, press the  button or turn the  dial clockwise.
- Press and hold the  buttons to browse through images quickly. Images appear grainy at this time.



- To access Scroll Display mode, turn the  dial rapidly. In this mode, turn the  dial to browse through images.
- To return to single-image display, press the  button.
- To browse images grouped by shooting date, press the  buttons in Scroll Display mode.
- Movies are identified by a  icon. To play movies, go to step 3.







### 3 Play movies.

- Press the **FUNC SET** button to access the movie control panel, choose **▶** (either press the **◀▶** buttons or turn the **DISP** dial), and then press the **FUNC SET** button again.
- ▶ Playback now begins, and after the movie is finished, **SET** is displayed.
- To adjust the volume, press the **▲▼** buttons.



• To switch to Shooting mode from Playback mode, press the shutter button halfway.

## Erasing the Images

You can choose and erase unneeded images one by one. Be careful when erasing images, because they cannot be recovered.

### 1 Choose an image to erase.

- Press the **◀▶** buttons or turn the **DISP** dial to choose an image.



### 2 Erase the images.

- Press the **🗑️** button.
- After [Erase?] is displayed, press the **◀▶** buttons or turn the **DISP** dial to choose [Erase], and then press the **FUNC SET** button.
- ▶ The current image is now erased.
- To cancel erasure, press the **◀▶** buttons or turn the **DISP** dial to choose [Cancel], and then press the **FUNC SET** button.

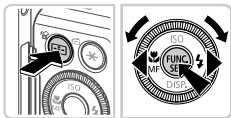

• You can also erase all images at once (p. 152).

## Included Software, PDF Manuals

The software and PDF manuals on the included CD-ROM are introduced below, with instructions for installation, saving images to a computer, and using the PDF manuals.

### Features of the Included Software

After installing the software on the CD-ROM, you can do the following things on your computer.



#### ZoomBrowser EX ImageBrowser

- Import images and change camera settings
- Manage images: browse, search, and organize
- Print and edit images

#### Digital Photo Professional

- Browse, process and edit RAW images

### PDF Manuals

The following PDF manuals are provided on the included CD-ROM.



#### Software Guide

Refer to the *software guide* when using the included software. Windows and Macintosh versions are provided.



#### Camera User Guide

Once you are familiar with the information in *Getting Started*, refer to this guide for a more in-depth understanding of camera operation.

## System Requirements

The included software can be used on the following computers. Adobe Reader is required to view the PDF manuals.

### Windows

Operating System	Windows 7 (including SP1) Windows Vista SP2 Windows XP SP3
Computer	Computers running one of the above operating systems (preinstalled), with an included USB port
Processor	Pentium 1.3 GHz or higher (still images), Core 2 Duo 2.6 GHz or higher (movies)
RAM	Windows 7 (64 bit): 2 GB or more Windows 7 (32 bit), Windows Vista (64 bit, 32 bit), Windows XP: 1 GB or more (still images), 2 GB or more (movies)
Interfaces	USB
Free Hard Disk Space	620 MB or more*
Display	1024 x 768 resolution or higher

\* In Windows XP, Microsoft .NET Framework 3.0 or later (max. 500 MB) must be installed. Installation may take some time, depending on computer performance.

### Macintosh

Operating System	Mac OS X 10.5 – 10.6
Computer	Computers running one of the above operating systems (preinstalled), with an included USB port
Processor	Intel Processor (still images), Core 2 Duo 2.6 GHz or higher (movies)
RAM	1 GB or more (still images), 2 GB or more (movies)
Interfaces	USB
Free Hard Disk Space	680 MB or more
Display	1024 x 768 resolution or higher



• Check the Canon website for the latest system requirements, including supported OS versions.

## Installing the Software and PDF Manuals

Windows 7 and Mac OS X 10.6 are used here for the sake of illustration.

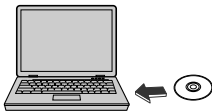

### 1 Insert the CD-ROM in the computer's CD-ROM drive.

- Insert the included CD-ROM (DIGITAL CAMERA Solution Disk) (p. 2) in the computer's CD-ROM drive.
- On a Macintosh computer, after inserting the disc, double-click the desktop disc icon to open it, and then double-click the  icon displayed.



### 2 Install the files.

- In Windows, click [Easy Installation], or on a Macintosh computer, click [Install]. Follow the on-screen instructions to complete the installation process.
- If the [User Account Control] window is displayed in Windows, follow the on-screen instructions.



### 3 Complete the installation.

- In Windows, click [Restart] or [Finish] and remove the CD-ROM after the desktop is displayed.
- On a Macintosh computer, click [Finish] on the screen after installation and remove the CD-ROM when the desktop is displayed.

## Saving Images to a Computer

Windows 7 and Mac OS X 10.6 are used here for the sake of illustration.

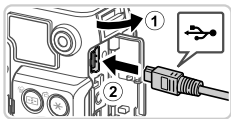

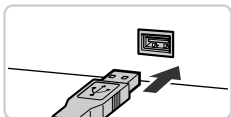

### 1 Connect the camera to the computer.

- Make sure the camera is off.
- Open the cover ( ① ). With the smaller plug of the included interface cable ( p. 2 ) in the orientation shown, insert the plug fully into the camera terminal ( ② ).
- Insert the larger plug of the interface cable in the computer's USB port. For details about USB connections on the computer, refer to the computer user manual.



### 2 Turn the camera on to access CameraWindow.

- Press the  button to turn the camera on.
- On a Macintosh computer, CameraWindow is displayed when a connection is established between the camera and computer.
- For Windows, follow the steps introduced below.
- In the screen that displays, click the  link to modify the program.



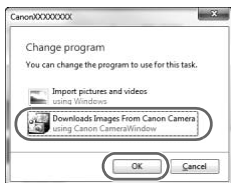

- Choose [Downloads Images From Canon Camera using Canon CameraWindow] and then click [OK].



- Double click .

### CameraWindow



### 3 Save the images to the computer.

- Click [Import Images from Camera], and then click [Import Untransferred Images].
- ▶ Images are now saved to the Pictures folder on the computer, in separate folders named by date.
- After images are saved, close CameraWindow, press the  button to turn the camera off, and unplug the cable.
- For instructions on viewing images on a computer, refer to the *Software Guide*.



- In Windows 7, if the screen in step 2 is not displayed, click the  icon in the taskbar.
- To start CameraWindow in Windows Vista or XP, click [Downloads Images From Canon Camera using Canon CameraWindow] on the screen displayed when you turn the camera on in step 2. If CameraWindow is not displayed, click the [Start] menu and choose [All Programs] ► [Canon Utilities] ► [CameraWindow] ► [CameraWindow].
- On a Macintosh computer, if CameraWindow is not displayed after step 2, click the [CameraWindow] icon in the Dock (the bar at the bottom of the desktop).
- Although you can save images to a computer simply by connecting your camera to the computer without using the included software, the following limitations apply.
  - It may take a few minutes after you connect the camera to the computer until camera images are accessible.
  - Images shot in vertical orientation may be saved in horizontal orientation.
  - RAW images (or JPEG images recorded with RAW images) may not be saved.
  - Image protection settings may be cleared from images saved to a computer.
  - Some problems may occur when saving images or image information, depending on the operating system version, the software in use, or image file sizes.
  - Some functions provided by the included software may not be available, such as editing movies or returning images to the camera.

## Using the PDF Manuals

You can access the PDF manuals by double-clicking the desktop shortcut icons created when the included CD-ROM is used for installation. Adobe Reader is required to view the PDF manuals.



Canon\_CUG



Software\_Gui...

# Accessories

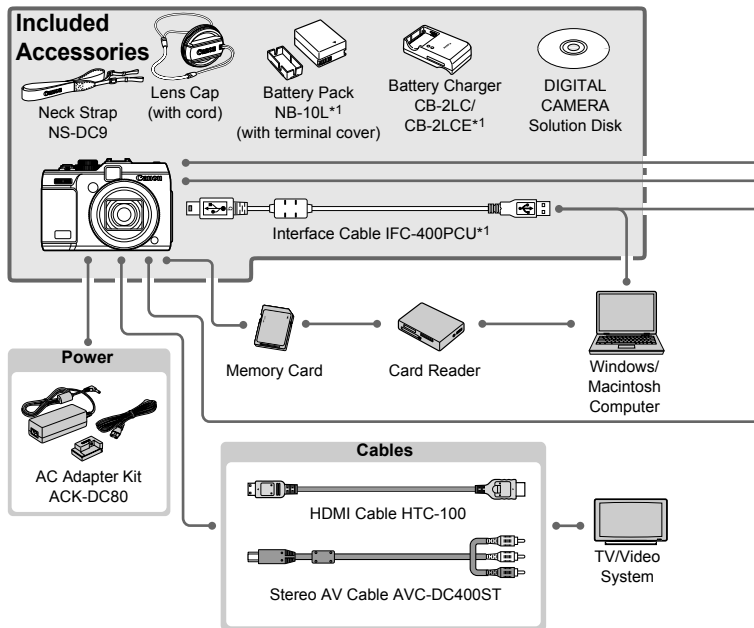

\*1 Also available for purchase separately.

\*2 Speedlite Transmitter ST-E2, Speedlite Bracket SB-E2 and Off-Camera Shoe Cord OC-E3 are also supported.

\*3 Bracket BKT-DC1, Off-Camera Shoe Cord OC-E3, Macrolite Adapter MLA-DC1 are required to attach these accessories.

\*4 Macrolite Adapter MLA-DC1 is required to attach this accessory.

\*5 Requires Waterproof Case Weight WW-DC1.

\*6 Filter Adapter FA-DC58C is required to attach this accessory.

## CAUTION

RISK OF EXPLOSION IF BATTERY IS REPLACED BY AN INCORRECT TYPE.  
DISPOSE OF USED BATTERIES ACCORDING TO LOCAL REGULATION.



## Flash Units



Speedlite\*2  
580EX II, 430EX II,  
320EX, 270EX II



Macro Twin Lite  
MT-24EX\*3



Macro Ring Lite  
MR-14EX\*4

## Cases



Waterproof Case  
WP-DC44 \*5



Soft Case  
SC-DC75

## Lens Accessories



Canon-brand Lens Filter  
(58 mm dia.)\*6



Lens Hood  
LH-DC70

## Canon PictBridge-Compatible Printers



## Other Accessories



Remote Switch RS60-E3

### Use of genuine Canon accessories is recommended.

This product is designed to achieve excellent performance when used with genuine Canon accessories.

Canon shall not be liable for any damage to this product and/or accidents such as fire, etc., caused by the malfunction of non-genuine Canon accessories (e.g., a leakage and/or explosion of a battery pack). Please note that this warranty does not apply to repairs arising out of the malfunction of non-genuine Canon accessories, although you may request such repairs on a chargeable basis.



# 1

## Camera Basics

| Basic camera operations and features

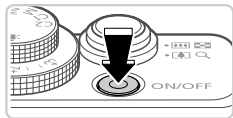



## Shooting Mode

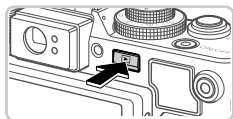

- Press the power button to turn the camera on and prepare for shooting.
- To turn the camera off, press the power button again.



## Playback Mode

- Press the  button to turn the camera on and view your shots.
- To turn the camera off, press the  button again.



- To switch to Playback mode from Shooting mode, press the  button.
- To switch to Shooting mode from Playback mode, press the shutter button halfway (p. 37).
- The lens will be retracted after about one minute once the camera is in Playback mode. You can turn the camera off when the lens is retracted by pressing the  button.

## Power-Saving Features (Auto Power Down)

As a way to conserve battery power, the camera automatically deactivates the screen and then turns itself off after a specific period of inactivity.

### Power Saving in Shooting Mode

The screen is automatically deactivated after about one minute of inactivity. In about two more minutes, the lens is retracted and the camera turns itself off. To activate the screen and prepare for shooting when the screen is off but the lens is still out, press the shutter button halfway (p. 37).

### Power Saving in Playback Mode

The camera turns itself off automatically after about five minutes of inactivity.



- You can deactivate these power-saving features if you prefer (p. 174).
- You can also adjust the timing of screen deactivation (p. 174).

## Shutter Button

To ensure your shots are in focus, always press the shutter button lightly (halfway) initially. Once the subject is in focus, press the button all the way down to shoot.

In this manual, shutter button operations are described as pressing the button halfway or all the way down.

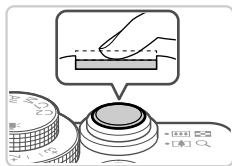

### 1 Press halfway. (Press lightly to focus.)

- Press the shutter button halfway. The camera beeps twice, and AF frames are displayed around image areas in focus.

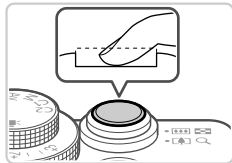

### 2 Press all the way down. (From the halfway position, press fully to shoot.)

- ▶ The camera shoots, as a shutter sound is played.
- Keep the camera still until the shutter sound ends.



- Images may be out of focus if you shoot without initially pressing the shutter button halfway.
- Length of shutter sound playback varies depending on the time required for the shot. It may take longer in some shooting scenes, and images will be blurry if you move the camera (or the subject moves) before the shutter sound ends.

# Optical Viewfinder

To conserve battery power when shooting, you can use the optical viewfinder instead of the screen. Shoot the same way as when using the screen.

---

## 1 Deactivate the screen.

- Press the ▼ button to turn the screen off (p. 39).

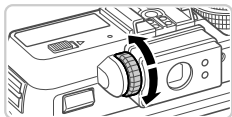

## 2 Adjust the diopter.

- As you look through the optical viewfinder, turn the dial one way or the other so that images look sharp.



- The area visible in the optical viewfinder may differ slightly from the image area in your shots.
- At aspect ratios other than 4:3, the area visible in the optical viewfinder differs from the image area in your shots. Check the settings before shooting.



- The lens may be partially visible through the optical viewfinder at some zoom positions.
- Although the camera automatically focuses on subjects, face detection and focusing is not possible.

## Shooting Modes

Use the mode dial to access each shooting mode.

### Auto Mode

Fully automatic shooting, with camera-determined settings (pp. 21, 44).

### Scene Mode

Shoot with optimal settings for specific scenes (p. 68).

### Creative Filters Mode

Add a variety of effects to images when shooting (p. 71).

### Movie Mode

For shooting movies (p. 88). You can also shoot movies when the mode dial is not set to Movie mode, simply by pressing the movie button.

### P, Tv, Av, M, C1, and C2 Modes

Take a variety of shots using your preferred settings (pp. 91, 123).

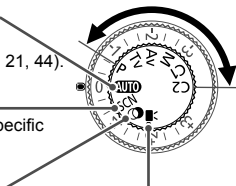

## Shooting Display Options

Press the ▼ button to view other information on the screen, or to hide the information. For details on the information displayed, see p. 222.

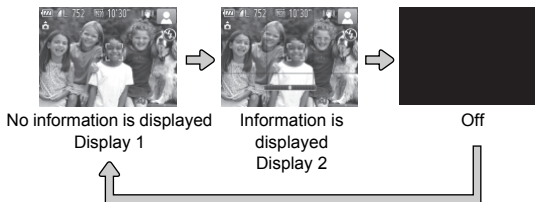

- Even if the screen is off, it will turn on when you start shooting a movie.



- Screen brightness is automatically increased by the night display function when you are shooting under low light, making it easier to check how shots are composed. However, on-screen image brightness may not match the brightness of your shots. Note that any on-screen image distortion or jerky subject motion will not affect recorded images.
- For playback display options, see p. 138.

# FUNC. Menu

Configure commonly used functions through the FUNC. menu as follows. Note that menu items and options vary depending on the shooting mode (pp. 226 – 233).







## 1 Access the FUNC. menu.

- Press the  button.







## 2 Choose a menu item.

- Press the   buttons to choose a menu item.
- ▶ Available options are shown at the bottom of the screen.
- In some menu items, functions can be specified simply by pressing the  or  button, or another screen is displayed for configuring the function.

Menu Items





## 3 Choose an option.

- Press the   buttons or turn the  dial to choose an option.
- Options labeled with a  icon can be configured by pressing the **MENU** button.



## 4 Finish the setup process.

- Press the  button.
- ▶ The screen before you pressed the  button in step 1 is displayed again, showing the option you configured.



- To undo any accidental setting changes, you can restore the camera's default settings (p. 179).



# MENU Menu

Configure a variety of camera functions through other menus as follows. Menu items are grouped by purpose on tabs, such as shooting (📷), playback (▶), and so on. Note that available settings vary depending on the selected shooting or playback mode (pp. 230 – 235).

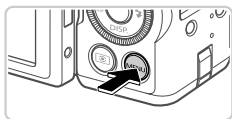

## 1 Access the menu.



- Press the **MENU** button.



## 2 Choose a tab.

- Move the zoom lever or press the ◀▶ buttons to choose a tab.

## 3 Choose a setting.

- Press the ▲▼ buttons or turn the  dial to choose a setting.
- To choose settings with options not shown, first press the  or ▶ button to switch screens, and then either press the ▲▼ buttons or turn the  dial to select the setting.
- Press the **MENU** button to restore the previous screen.

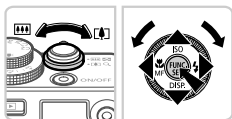

## 4 Choose an option.

- Press the ◀▶ buttons to choose an option.

## 5 Finish the setup process.

- Press the **MENU** button to return to the screen displayed before you pressed the **MENU** button in step 1.

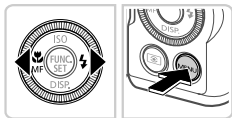

• To undo any accidental setting changes, you can restore the camera's default settings (p. 179).

## Indicator Display

The power lamp and indicator on the back of the camera (p. 5) will light or blink depending on the camera's status.

Indicator	Color	Indicator Status	Camera Status
Power Lamp	Green	On	Camera on
		Blinking	Low battery
Indicator	Green	On	Ready to shoot (when the flash is deactivated)
		Blinking	Recording/recording/transmitting images Distance warning (p. 217), or cannot focus (when the flash is deactivated) (p. 217)
	Orange	On	Ready to shoot (when the flash is activated)
		Blinking	Distance warning (p. 217), or cannot focus (when the flash is activated) (p. 217)







- When the indicator blinks green, never turn the camera off, open the memory card/battery cover, or shake or jolt the camera, which may corrupt images or damage the camera or memory card.

## Clock

You can check the current time.



- Press and hold the  button.
- The current time appears.
- If you hold the camera vertically while using the clock function, it will switch to vertical display. Press the   buttons or turn the  dial to change the display color.
- Press the  button again to cancel the clock display.



- When the camera is off, press and hold the  button, then press the power button to display the clock.

# 2

## **Smart Auto Mode**

Convenient mode for easy shots with greater control over shooting

# Shooting in Smart Auto Mode

For fully automatic selection at optimal settings for specific scenes, simply let the camera determine the subject and shooting conditions.

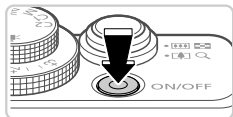

## 1 Turn the camera on.

- Press the power button.
- ▶ The startup screen is displayed.

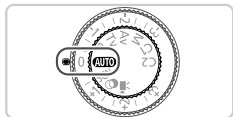

## 2 Enter **AUTO** mode.

- Set the mode dial to **AUTO**.
- Aim the camera at the subject. The camera will make a slight clicking noise as it determines the scene.
- ▶ Icons representing the scene and image stabilization mode are displayed in the upper right of the screen (pp. 48, 49).
- ▶ Frames displayed around any detected subjects indicate that they are in focus.



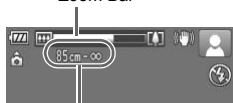

Zoom Bar



Focus Range (approx.)

## 3 Compose the shot.

- To zoom in and enlarge the subject, move the zoom lever toward  (telephoto), and to zoom away from the subject, move it toward  (wide angle). (A zoom bar showing the zoom position is displayed.)

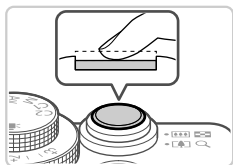

## 4 Shoot.

### Shooting Still Images

#### ① Focus.

- Press the shutter button halfway. The camera beeps twice after focusing, and AF frames are displayed to indicate image areas in focus.



AF Frames

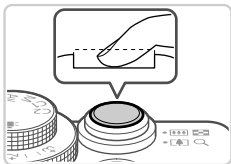
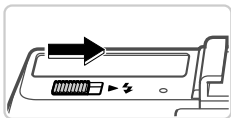

Elapsed Time



- Several AF frames are displayed when multiple areas are in focus.

- If [Raise the flash] appears on the screen, move the  switch to raise the flash. It will fire when shooting. If you prefer not to use the flash, push it down with your finger, into the camera.

## ② Shoot.

- Press the shutter button all the way down.
- ▶ As the camera shoots, a shutter sound is played, and in low-light conditions when you have raised the flash, it fires automatically.
- ▶ Your shot remains displayed on the screen for about two seconds.
- Even while the shot is displayed, you can take another shot by pressing the shutter button again.

## Shooting Movies

### ① Start shooting.

- If the flash is already up, push it down with your finger, into the camera.
- Press the movie button. The camera beeps once as recording begins, and [●Rec] is displayed with the elapsed time.
- ▶ Black bars displayed on the top and bottom edges of the screen indicate image areas not recorded.
- Once recording begins, you can take your finger off the movie button.

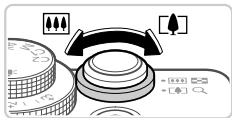

### ② Resize the subject and recompose the shot as needed.

- To resize the subject, do the same thing as in step 3 on p. 44. However, note that the sound of camera operations will be recorded.
- When you recompose shots, the focus, brightness, and colors will be automatically adjusted.

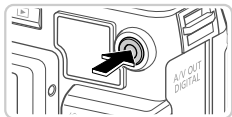

### ③ Finish shooting.

- Press the movie button again to stop shooting. The camera beeps twice as recording stops.
- Recording will stop automatically when the memory card becomes full.

## ■ Still Images/Movies

- ❗ To activate the screen when the camera is on but the screen is blank, press the ▼ button (p. 39).
- To restore camera sound if you have accidentally deactivated it (by holding the ▼ button down while turning the camera on), press the **MENU** button and choose [Mute] on the **↑** tab, and then press the **◀▶** buttons to choose [Off].

## ■ Still Images

- ❗ A flashing  icon warns that images are more likely to be blurred by camera shake. In this case, attach the camera to a tripod or take other measures to keep it still.
- If your shots are dark despite the flash firing, move closer to the subject. For details on the flash range, see “Specifications” in the *Getting Started* guide.
- The subject may be too close if the camera only beeps once when you press the shutter button halfway. For details on the focusing range (shooting range), see “Specifications” in the *Getting Started* guide.
- To reduce red-eye and to assist in focusing, the lamp may be activated when shooting in low-light conditions.

- A blinking ⚡ icon displayed when you attempt to shoot indicates that shooting is not possible until the flash has finished recharging. Shooting can resume as soon as the flash is ready, so either press the shutter button all the way down and wait, or release it and press it again.



- The flash firing during shots indicates that the camera has automatically attempted to ensure optimal colors in the main subject and background (Multi-area White Balance).

## Movies



Microphone

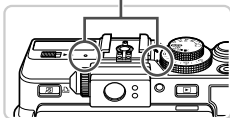

- Before shooting a movie, lower the flash with your finger. Be careful not to touch the microphone when shooting a movie. Leaving the flash raised, or blocking the microphone may prevent audio from being recorded or may cause the recording to sound muffled.
- Avoid touching camera controls other than the movie button when shooting movies, because sounds made by the camera will be recorded.
- To correct suboptimal image color that may occur in 1920 movie shooting (p. 60) after you recompose shots, press the movie button to stop recording, and then press it again to resume recording.



- Audio is recorded in stereo.

## Scene Icons

In **AUTO** mode, shooting scenes determined by the camera are indicated by the icon displayed, and corresponding settings are automatically selected for optimal focusing, subject brightness, and color.

Background \ Subject	People			Other Subjects			Icon Background Color	
		In Motion* <sup>1</sup>	Shadows on Face* <sup>1</sup>		In Motion* <sup>1</sup>	At Close Range		
Bright					AUTO			Gray
	Backlit			—				
With Blue Sky					AUTO			Light Blue
	Backlit			—				
Sunsets		—	—		—	—	Orange	
Spotlights			—		—		Dark Blue	
Dark				AUTO	—			
Tripod Used		—	—		—	—		

\*1 Not displayed for movies.

\*2 Displayed in dark scenes when the camera is held still, as when mounted on a tripod.









- Try shooting in **P** mode (p. 91) if the scene icon does not match actual shooting conditions, or if it is not possible to shoot with your expected effect, color, or brightness.



## Image Stabilization Icons

Optimal image stabilization for the shooting conditions is automatically applied (Intelligent IS). Additionally, the following icons are displayed in **AUTO** mode.

	Image stabilization for still images		Image stabilization for movies, reducing strong camera shake, as when shooting while walking (Dynamic IS)
	Image stabilization for still images, when panning*		Image stabilization for subtle camera shake, such as when shooting movies at telephoto (Powered IS)
	Image stabilization for macro shots (Hybrid IS)		No image stabilization, because the camera is mounted on a tripod or held still by other means

\* Displayed when you pan, following moving subjects with the camera. When you follow subjects moving horizontally, image stabilization only counteracts vertical camera shake, and horizontal stabilization stops. Similarly, when you follow subjects moving vertically, image stabilization only counteracts horizontal camera shake.



- To cancel image stabilization, set [IS Mode] to [Off] (p. 120). In this case, an IS icon is not displayed.

## On-Screen Frames

A variety of frames are displayed once the camera detects subjects you are aiming the camera at.

- A white frame is displayed around the subject (or person's face) determined by the camera to be the main subject, and gray frames are displayed around other detected faces. Frames follow moving subjects within a certain range to keep them in focus. However, if the camera detects subject movement, only the white frame will remain on the screen.
- When you are pressing the shutter button halfway and the camera detects subject movement, a blue frame is displayed, and the focus and image brightness are constantly adjusted (Servo AF).



- Try shooting in **P** mode (p. 91) if no frames are displayed, if frames are not displayed around desired subjects, or if frames are displayed on the background or similar areas.

## Zooming In Closer on Subjects (Digital Zoom)

When distant subjects are too far away to enlarge using the optical zoom, use digital zoom for up to about 16x enlargement.

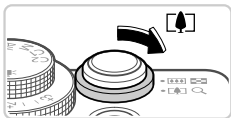

### 1 Move the zoom lever toward .

- Hold the lever until zooming stops.
- ▶ Zooming stops at the largest possible zoom factor (before the image becomes grainy), which is displayed when you release the zoom lever.

Zoom Factor



### 2 Move the zoom lever toward again.

- ▶ The camera zooms in even closer on the subject, using digital zoom.

- ⚠ Zoomed images may look grainy, under some resolution settings (p. 57) and zoom factors. In this case, the zoom factor is shown in blue.



- Focal length when optical and digital zoom are combined is as follows (35mm film equivalent).  
28 – 448 mm (28 – 112 mm with optical zoom alone)
- To deactivate digital zoom, press the **MENU** button, choose [Digital Zoom] on the  tab, and then choose [Off].

## Using the Self-Timer

With the self-timer, you can include yourself in group photos or other timed shots. The camera will shoot about 10 seconds after you press the shutter button.



### 1 Configure the setting.

- Press the **FUNC. SET** button, choose **COFF** in the menu, and then choose the **10** option (p. 40).
- ▶ Once the setting is complete, **10** is displayed.

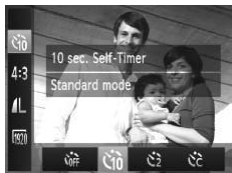

### 2 Shoot.

- For Still Images: Press the shutter button halfway to focus on the subject, and then press it all the way down.
- For Movies: Press the movie button.
- ▶ Once you start the self-timer, the lamp will blink and the camera will play a self-timer sound.
- ▶ Two seconds before the shot, the blinking and sound will speed up. (When the flash fires, the lamp will remain lit.)
- To cancel shooting after you have triggered the self-timer, press the **MENU** button.
- To restore the original setting, choose **COFF** in step 1.

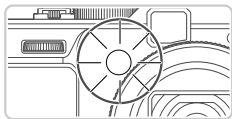

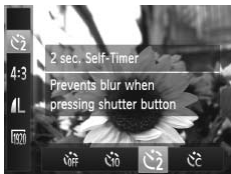

## Using the Self-Timer to Avoid Camera Shake

This option delays shutter release until about two seconds after you have pressed the shutter button. If the camera is unsteady while you are pressing the shutter button, it will not affect your shot.



### Configure the setting.

- Follow step 1 on p. 52 and choose .
- ▶ Once the setting is complete,  is displayed.
- Follow step 2 on p. 52 to shoot.

## Customizing the Self-Timer





You can specify the delay (0 – 30 seconds) and number of shots (1 – 10).



### 1 Choose .

- Follow step 1 on p. 52, choose , and then press the **MENU** button.

### 2 Configure the setting.

- Turn the  dial to choose [Delay], either press the  buttons or turn the  dial to choose [Shots], and then press the  button.
- ▶ Once the setting is complete,  is displayed.
- Follow step 2 on p. 52 to shoot.



- For movies shot using the self-timer, [Delay] represents the delay before recording begins, but the [Shots] setting has no effect.



- When you specify multiple shots, image brightness and white balance are determined by the first shot. More time is required between shots when the flash fires or when you have specified to take many shots. Shooting will stop automatically when the memory card becomes full.
- When a delay longer than two seconds is specified, two seconds before the shot, the lamp blinking and self-timer sound will speed up. (When the flash fires, the lamp will remain lit.)

## Adding the Shooting Date and Time

The camera can add the shooting date and time to images in the lower-right corner. However, note that these cannot be removed. Confirm beforehand that the date and time are correct (p. 18).

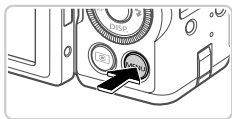

### 1 Configure the setting.

- Press the **MENU** button, choose [Date Stamp] on the  tab, and then choose the desired option (p. 41).
- ▶ Once the setting is complete, [DATE] is displayed.

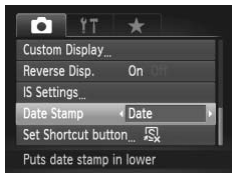

### 2 Shoot.

- ▶ As you take shots, the camera adds the shooting date or time to the lower-right corner of images.
- To restore the original setting, choose [Off] in step 1.



- Images originally recorded without the date and time can be printed with this information as follows. However, adding the date and time to images that already have this information may cause it to be printed twice.
  - Use camera DPOF print settings (p. 208) to print
  - Use the included software to print
 For details, refer to the *Software Guide*.
  - Print using printer functions (p. 202)

## Choosing Subjects to Focus On (Tracking AF)

Shoot after choosing a subject to focus on as follows.



### 1 Specify Tracking AF.

- Press the ▲ button.
- ▶ □ is displayed in the center of the screen.



### 2 Choose a subject to focus on.

- Aim the camera so that □ is on the desired subject, and then press the shutter button halfway.
- ▶ A blue frame is displayed, and the camera will keep the subject in focus and image brightness adjusted (Servo AF).

### 3 Shoot.

- Press the shutter button all the way down to shoot.
- Press the ▲ button to cancel Tracking AF.



- Tracking may not be possible when subjects are too small or move too rapidly, or when subject color or brightness matches that of the background too closely.

## Changing the Aspect Ratio

Change the image aspect ratio (ratio of width to height) as follows.



### Configure the setting.

- Press the **FUNC/SET** button, choose **4:3** in the menu, and choose the desired option (p. 40).
- ▶ Once the setting is complete, the screen aspect ratio will be updated.
- To restore the original setting, repeat this process but choose **4:3**.

<b>16:9</b>	Same aspect ratio as HDTVs, used for display on widescreen HDTVs or similar display devices.
<b>3:2</b>	Same aspect ratio as 35 mm film, used for printing images at 5 x 7-inch or postcard sizes.
<b>4:3</b>	Native aspect ratio of the camera screen, used for printing images at 3.5 x 5-inch or A-series sizes.
<b>1:1</b>	Square aspect ratio.
<b>4:5</b>	Aspect ratio commonly used for portraits.



- At aspect ratios other than **4:3**, digital zoom (p. 51) is not available ([Digital Zoom] is set to [Off]).



## Changing Image Resolution (Size)

Choose from 4 levels of image resolution, as follows. For guidelines on how many shots at each resolution setting can fit on a memory card, see “Specifications” in the *Getting Started* guide.



### Configure the setting.



- Press the **FUNC/SET** button, choose **L** in the menu, and choose the desired option (p. 40).
- ▶ The option you configured is now displayed.
- To restore the original setting, repeat this process but choose **L**.

### Guidelines for Choosing Resolution Based on Paper Size (for 4:3 Images)

A2 (16.5 x 23.4 in.)	<b>L</b>
A3 – A5 (11.7 x 16.5 – 5.8 x 8.3 in.)	<b>M1</b>
5 x 7 in. Postcard 3.5 x 5 in.	<b>M2</b>



- **S** : For e-mailing images.

## Changing the Compression Ratio (Image Quality)

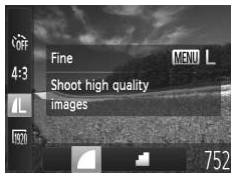
Choose from two compression ratios, as follows:  (Fine),  (Normal). For guidelines on how many shots at each compression ratio can fit on a memory card, see “Specifications” in the *Getting Started* guide.



### Configure the setting.



- Press the  button, choose  in the menu, press the **MENU** button, and choose the desired option (p. 40).
- ▶ The option you configured is now displayed.
- To restore the original setting, repeat this process but choose .

## Red-Eye Correction

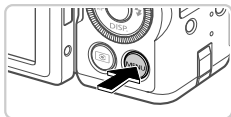
Red-eye that occurs in the flash photography can be automatically corrected as follows.



### 1 Access the [Built-in Flash Settings] screen.

- Press the **MENU** button, choose [Flash Control] on the  tab, and then press the  button (p. 41).

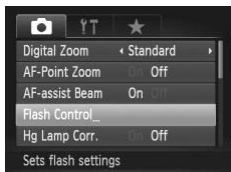

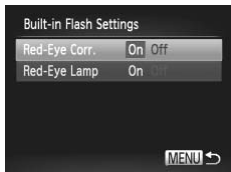



## 2 Configure the setting.

- Choose [Red-Eye Corr.], and then choose [On] (p. 41).
- ▶ Once the setting is complete,  is displayed.
- To restore the original setting, repeat this process but choose [Off].

-  Red-eye correction may be applied to image areas other than eyes (if the camera misinterprets red eye makeup as red pupils, for example).

-  You can also correct existing images (p. 164).
- You can also access the screen in step 2 when the flash is up by pressing the  button and immediately pressing the **MENU** button.



### Still Images

## Correcting Greenish Image Areas from Mercury Lamps

In shots of evening scenes with subjects illuminated by mercury lamps, the subjects or background may appear to have a greenish tinge. This greenish tinge can be corrected automatically when shooting, using Multi-area White Balance.



## Configure the setting.

- Press the **MENU** button, choose [Hg Lamp Corr.] on the  tab, and then choose [On] (p. 41).
- ▶ Once the setting is complete,  is displayed.
- To restore the original setting, repeat this process but choose [Off].



- ! After you are finished shooting under mercury lamps, you should set [Hg Lamp Corr.] back to [Off]. Otherwise, green hues not caused by mercury lamps may be corrected by mistake.



- Try taking some test shots first, to make sure you obtain the desired results.

## Changing Movie Image Quality

3 image quality settings are available. For guidelines on the maximum movie length at each level of image quality that will fit on a memory card, see “Specifications” in the *Getting Started* guide.



### Configure the setting.

- Press the **FUNC/SET** button, choose **1920** in the menu, and choose the desired option (p. 40).
- ▶ The option you configured is now displayed.
- To restore the original setting, repeat this process but choose **1920**.

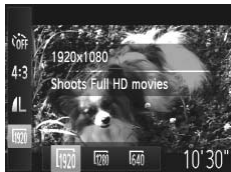





Image Quality	Resolution	Frame Rate	Details
	1920 x 1080	24 fps	For shooting in Full HD
	1280 x 720	30 fps	For shooting in HD
	640 x 480	30 fps	For shooting in standard definition



- In  and  modes, black bars displayed on the top and bottom edges of the screen indicate image areas not recorded.

Movies

## Using the Wind Filter

Distorted audio caused by recording when the wind is strong can be reduced. However, the recording may sound unnatural when this option is used when there is no wind.

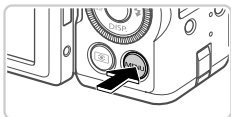

### Configure the setting.

- Press the **MENU** button, choose [Wind Filter] on the  tab, and then choose [On] (p. 41).
- To restore the original setting, repeat this process but choose [Off].



## Using the Electronic Level

An electronic level can be displayed on the screen when shooting as a guideline to determine if the camera is level.



### 1 Display the electronic level.

- Press the **▼** button several times to display the electronic level.



### 2 Level the camera as needed.

- Level the camera so that the center of the electronic level is green.

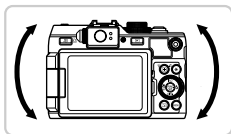

- If the electronic level is not displayed in step 1, press the **MENU** button, and on the **☑** tab, choose [Custom Display]. Add a **✓** to **LV** or **RV** to choose the electronic level.
- Tilting the camera too far forward or backward will prevent you from using the electronic level, which will turn gray.
- The electronic level is not displayed during movie recording.
- If you hold the camera vertically, the orientation of the electronic level will be updated automatically to match the camera orientation.
- If your shots are not level even if you use the electronic level, try calibrating the electronic level (p. 176).

## Magnifying the Area in Focus

You can check the focus by pressing the shutter button halfway to enlarge the image area in the AF frame.

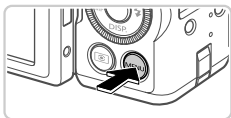

### 1 Configure the setting.

- Press the **MENU** button, choose [AF-Point Zoom] on the  tab, and then choose [On] (p. 41).



### 2 Check the focus.

- Press the shutter button halfway. The face detected as the main subject is now magnified.
- To restore the original setting, choose [Off] in step 1.



- The display will not magnify if a face was not detected, or if the person is too close to the camera and their face is too large for the screen.



- The display will not magnify when using the digital zoom (p. 51) or Tracking AF (p. 55).

## Checking for Closed Eyes

 is displayed when the camera detects that people may have closed their eyes.

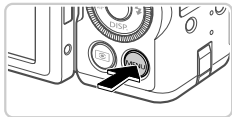

### 1 Configure the setting.

- Press the **MENU** button, choose [Blink Detection] on the  tab, and then choose [On] (p. 41).

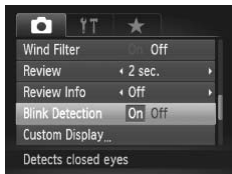

### 2 Shoot.

- ▶ A frame, accompanied by , is displayed when the camera detects a person whose eyes are closed.
- To restore the original setting, choose [Off] in step 1.



- When you have specified multiple shots in  mode, this function is only available for the final shot.



## Customizing Camera Operation

Customize shooting functions on the  tab of the menu as follows. For instructions on menu functions, see “MENU Menu” (p. 41).

### Deactivating the AF Assist Beam

You can deactivate the lamp that normally lights up to help you focus when you press the shutter button halfway in low-light conditions.

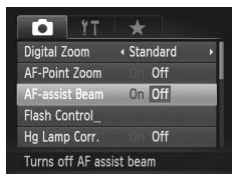

#### Configure the setting.



- Press the **MENU** button, choose [AF-assist Beam] on the  tab, and then choose [Off] (p. 41).
- To restore the original setting, repeat this process but choose [On].

### Deactivating the Red-Eye Reduction Lamp

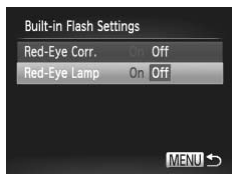
You can deactivate the red-eye reduction lamp that lights up to reduce red-eye when the flash is used in low-light shots.



#### 1 Access the [Built-in Flash Settings] screen.

- Press the **MENU** button, choose [Flash Control] on the  tab, and then press the  button (p. 41).

#### 2 Configure the setting.

- Choose [Red-Eye Lamp], and then choose [Off] (p. 41).
- To restore the original setting, repeat this process but choose [On].

## Changing the Image Display Period After Shots

Change how long images are displayed after shots as follows.



### Configure the setting.

- Press the **MENU** button, choose [Review] on the tab, and then choose the desired option (p. 41).
- To restore the original setting, repeat this process but choose [2 sec.].

2 – 10 sec.	Displays images for the specified time.
Hold	Displays images until you press the shutter button halfway.
Off	No image display after shots.

## Changing the Image Display Style After Shots

Change the way images are displayed after shots as follows.



### Configure the setting.

- Press the **MENU** button, choose [Review Info] on the tab, and then choose the desired option (p. 41).
- To restore the original setting, repeat this process but choose [Off].

Off	Displays only the image.
Detailed	Displays shooting details (p. 224).
Focus Check	Shows the area in the AF frame magnified, enabling you to check the focus. Follow the steps in "Checking the Focus" (p. 139).



## Specific Scenes

Choose a mode matching the shooting scene, and the camera will automatically configure the settings for optimal shots.

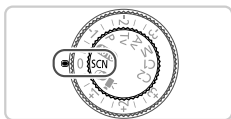

### 1 Enter SCN mode.

- Set the mode dial to **SCN**.

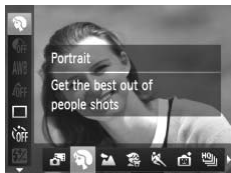

### 2 Choose a shooting mode.

- Press the **FUNC/SET** button, choose  in the menu, and then choose a shooting mode (p. 40).

### 3 Shoot.



### Shoot portraits (Portrait)

- Take shots of people with a softening effect.



### Shoot landscapes (Landscape)

- Shoot majestic landscapes with a real sense of depth.



### Take shots of kids and pets (Kids&Pets)

- Capture subjects that move around, such as children and pets, without missing photo opportunities.
- For details on the shooting range, see “Specifications” in the *Getting Started* guide.



Still Images

### Shoot moving subjects (Sports)

- Shoot continuously as the camera keeps the subject in focus.
- For details on the shooting range, see “Specifications” in the *Getting Started* guide.



Still Images

### Shoot evening scenes without using a tripod (Handheld NightScene)

- Beautiful shots of evening scenes, created by combining consecutive shots to reduce camera shake and image noise.
- When using a tripod, shoot in **AUTO** mode (p. 44).



Still Images

Movies

### Shoot at the beach (Beach)

- Take shots of brightly lit people on sandy beaches where the reflected sunlight is strong.



Still Images

Movies

### Shoot under water (Underwater)

- Natural-colored shots of sea life and underwater scenery, when you use an optional waterproof case (p. 184).

Still Images

Movies



### Take shots of foliage (Foliage)

- Shoot trees and leaves, such as new growth, autumn leaves or blossoms, in vivid colors.

Still Images

Movies



### Shoot with snowy backgrounds (Snow)

- Bright, natural-colored shots of people against snowy backgrounds.

Still Images



Movies







### Shoot fireworks (Fireworks)

- Vivid shots of fireworks.



- Because the camera will shoot continuously in  mode, hold it steady while shooting.
- In  mode, shooting conditions that cause excessive camera shake or similar issues may prevent the camera from combining images, and you may not be able to obtain the expected results.
- In  mode, mount the camera on a tripod or take other measures to keep it still and prevent camera shake. In this case, set [IS Mode] to [Off] (p. 120).



- In , , , and  modes, shots may look grainy because the ISO speed (p. 95) is increased to suit the shooting conditions.

# Image Effects (Creative Filters)

Add a variety of effects to images when shooting.

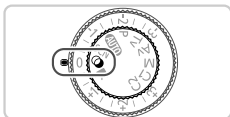

## 1 Enter mode.







- Set the mode dial to .



## 2 Choose a shooting mode.

- Press the  button, choose HDR in the menu, and then choose a shooting mode (p. 40).

## 3 Shoot.

-  • In , , , , , and  modes, try taking some test shots first, to make sure you obtain the desired results.



## Shoot in vivid colors (Super Vivid)

- Shots in rich, vivid colors.



## Posterized shots (Poster Effect)

- Shots that resemble an old poster or illustration.

## Shooting High-Contrast Scenes (High Dynamic Range)

Three consecutive images are captured at different brightness levels each time you shoot, and the camera combines image areas with optimal brightness to create a single image. This mode can reduce the washed-out highlights and loss of detail in shadows that tends to occur in high-contrast shots.

### 1 Choose HDR.

- Follow steps 1 – 2 on p. 71 and choose HDR.



### 2 Hold the camera still.

- Mount the camera on a tripod or take other measures to keep it still and prevent camera shake.

### 3 Shoot.

- When you press the shutter button all the way down, the camera will take three shots and combine them.



- Set the [IS Mode] to [Off] (p. 120) in this mode.



- Any subject movement will cause images to look blurry.
- There will be a delay before you can shoot again, as the camera processes and combines the images.



## Adding Color Effects



### Choose a color effect.

- Follow steps 1 – 2 on p. 71 and choose HDR.
- Press the button, choose a color effect (either press the buttons or turn the dial), and then press the button again.

Effect Off	—
Sepia	Sepia tone shots.
B/W	Black and white shots.
Super Vivid	Shots in rich, vivid colors.
Poster Effect	Shots that resemble an old poster or illustration.

Still Images

Movies

## Shooting with Faded Colors (Nostalgic)

This effect makes colors look faded and images look weathered, as in old photographs. Choose from five effect levels.

### 1 Choose .

- Follow steps 1 – 2 on p. 71 and choose .

### 2 Choose an effect level.

- Turn the dial to choose an effect level.

### 3 Shoot.



- Colors will look faded on the shooting screen, but the image aging effect is not shown. Review the image in Playback mode to see the effect (p. 136).
- The image aging effect is not applied to movies.

## Shooting with a Fish-Eye Lens Effect (Fish-eye Effect)

Shoot with the distorting effect of a fish-eye lens.

### 1 Choose .

- Follow steps 1 – 2 on p. 71 and choose .



### 2 Choose an effect level.

- Turn the  dial to choose an effect level.
- ▶ A preview is shown of how your shot will look with the effect applied.

### 3 Shoot.

## Shots Resembling Miniature Models (Miniature Effect)

Creates the effect of a miniature model, by blurring image areas above and below your selected area.



You can also make movies that look like scenes in miniature models by choosing the playback speed before the movie is recorded. People and objects in the scene will move quickly during playback. Note that sound is not recorded.

### 1 Choose .

- Follow steps 1 – 2 on p. 71 and choose .
- ▶ A white frame is displayed, indicating the image area that will not be blurred.



### 2 Choose the area to keep in focus.

- Press the  button.
- Move the zoom lever to resize the frame, and turn the  dial to move it.

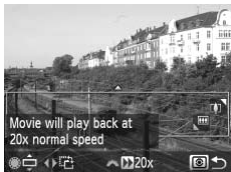

### 3 For movies, choose the movie playback speed.

- Turn the dial to choose the speed.

### 4 Return to the shooting screen and shoot.

- Press the button to return to the shooting screen, and then shoot.

## Playback Speed and Estimated Playback Time (for One-Minute Clips)

Speed	Playback Time
5x	Approx. 12 sec.
10x	Approx. 6 sec.
20x	Approx. 3 sec.



- The zoom is not available when shooting movies. Be sure to set the zoom before shooting.



- To switch the orientation of the frame to vertical, press the buttons in step 2. To return the frame to horizontal orientation, press the buttons.
- To move the frame when it is in horizontal orientation press the buttons, and to move the frame when it is in vertical orientation, press the buttons.
- Holding the camera vertically will change the orientation of the frame.
- Movie image quality is at an aspect ratio of 4:3 and at an aspect ratio of 16:9 (p. 56). These quality settings cannot be changed.

## Shooting with a Toy Camera Effect (Toy Camera Effect)

This effect makes images resemble shots from a toy camera by vignetting (darker, blurred image corners) and changing the overall color.

### 1 Choose .

- Follow steps 1 – 2 on p. 71 and choose .



### 2 Choose a color tone.

- Turn the  dial to choose a color tone.
- ▶ A preview is shown of how your shot will look with the effect applied.

### 3 Shoot.

Standard	Shots resemble toy camera images.
Warm	Images have a warmer tone than with [Standard].
Cool	Images have a cooler tone than with [Standard].

## Shooting in Monochrome

Shoot images in black and white, sepia, or blue and white.

### 1 Choose .

- Follow steps 1 – 2 on p. 71 and choose .

### 2 Choose a color tone.

- Turn the  dial to choose a color tone.
- ▶ A preview is shown of how your shot will look with the effect applied.

### 3 Shoot.



B/W	Black and white shots.
Sepia	Sepia tone shots.
Blue	Blue and white shots.

## Shooting with Color Accent

Choose a single image color to keep and change other colors to black and white.

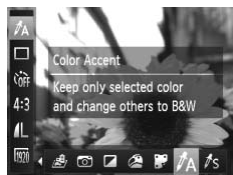

### 1 Choose .

- Follow steps 1 – 2 on p. 71 and choose .

### 2 Access the setting screen.

- Press the  button.
- ▶ The original image and the Color Accent image are displayed one after another.
- ▶ By default, green is the color that will be kept.







Recorded Color

### 3 Specify the color.

- Position the center frame over the color to keep, and then press the  button.
- ▶ The specified color is recorded.

### 4 Specify the range of colors to keep.

- Press the   buttons or turn the  dial to adjust the range.
- To keep only your specified color, choose a large negative value. To keep colors similar to your specified color as well, choose a large positive value.
- Press the  button to return to the shooting screen.



- Using the flash in this mode may cause unexpected results.
- In some shooting scenes, images may look grainy and colors may not look as expected.

## Shooting with Color Swap

You can replace one image color with another before shooting. Note that only one color can be replaced.

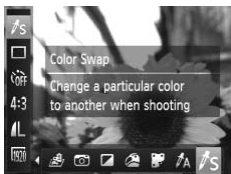

### 1 Choose .

- Follow steps 1 – 2 on p. 71 and choose .

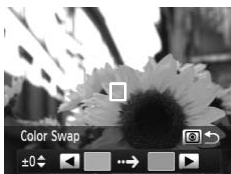

### 2 Access the setting screen.

- Press the  button.
  - ▶ The original image and the Color Swap image are displayed one after another.
  - ▶ By default, green will be replaced with gray.

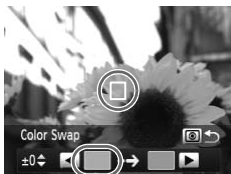

### 3 Specify the color to replace.



- Position the center frame over the color to replace, and then press the  button.
  - ▶ The specified color is recorded.



### 4 Specify the new color.

- Position the center frame over the new color, and then press the  button.
  - ▶ The specified color is recorded.

### 5 Specify the range of colors to replace.

- Press the   buttons or turn the  dial to adjust the range.

- To replace only your specified color, choose a large negative value. To replace colors similar to your specified color as well, choose a large positive value.
- Press the  button to return to the shooting screen.



- Using the flash in this mode may cause unexpected results.
- In some shooting scenes, images may look grainy and colors may not look as expected.



## Auto Clip Recording (Movie Digest)

You can make a short movie of a day just by shooting still images. Before each shot, the camera will automatically record a movie clip of the scene. Each clip recorded that day is combined into a single file.

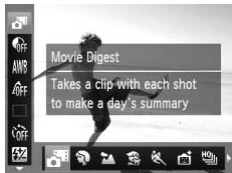

### 1 Choose .

- Follow steps 1 – 2 on p. 68 and choose .



### 2 Shoot.

- To shoot a still image, press the shutter button all the way down.
- ▶ Before shooting, the camera will automatically record a clip about 2 – 4 seconds long.



- Clips may not be recorded if you shoot a still image immediately after turning the camera on, choosing  mode, or operating the camera in other ways.
- Battery life is shorter in this mode than in **AUTO** mode, because clips are recorded for each shot.
- Any sounds from camera operations during movie recording will be included in the movie.



-  mode movie quality is **640** and cannot be changed.
- Clips are saved as separate movie files in the following cases even if they were recorded on the same day in  mode.
  - If the movie file size reaches about 4 GB or the total recording time reaches approx. 1 hour
  - If a movie is protected (p. 148)
  - If a movie has been edited (p. 165)
  - When the daylight saving time (p. 19) or time zone settings have been changed (p. 175)
  - If a new folder is created (p. 173)
  - If the copyright information is changed or deleted (p. 177)
- Some camera sounds will be muted. Sounds are not played when you press the shutter button halfway, use camera controls, or trigger the self-timer (p. 169).
- Movies created in  mode can be viewed by date (p. 143).





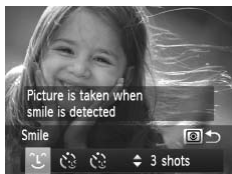

## Auto Shooting After Face Detection (Smart Shutter)

### Auto Shooting After Smile Detection

The camera shoots automatically after detecting a smile, even without you pressing the shutter button.





#### 1 Choose .

- Follow steps 1 – 2 on p. 68 and choose , and then press the  button.
- Press the   buttons or turn the  dial to choose , and then press the  button.
- ▶ The camera now enters shooting standby mode, and [Smile Detection on] is displayed.





#### 2 Aim the camera at a person.

- Each time the camera detects a smile, it will shoot after the lamp lights up.
- To pause smile detection, press the  button. Press the  button again to resume detection.



- Switch to another mode when you finish shooting, or the camera will continue shooting each time a smile is detected.









- You can also shoot as usual by pressing the shutter button.
- The camera can detect smiles more easily when subjects face the camera and open their mouth wide enough so that teeth are visible.
- To change the number of shots, press the   buttons after choosing  in step 1. [Blink Detection] (p. 64) is only available for the final shot.

## Using the Wink Self-Timer

Aim the camera at a person and press the shutter button all the way down. The camera will shoot about two seconds after a wink is detected.



### 1 Choose .

- Follow steps 1 – 2 on p. 68 and choose , and then press the .
- Press the  buttons or turn the  dial to choose , and then press the .

### 2 Compose the shot and press the shutter button halfway.

- Make sure a green frame is displayed around the face of the person who will wink.

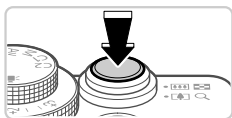

### 3 Press the shutter button all the way down.



- ▶ The camera now enters shooting standby mode, and [Wink to take picture] is displayed.
- ▶ The lamp blinks and the self-timer sound is played.



### 4 Face the camera and wink.

- ▶ The camera will shoot about two seconds after detecting a wink by the person whose face is inside the frame.
- To cancel shooting after you have triggered the self-timer, press the **MENU** button.









- If the wink is not detected, wink again slowly and deliberately.
- Winking may not be detected if eyes are obscured by hair, a hat, or glasses.
- Closing and opening both eyes at once will also be detected as a wink.
- If winking is not detected, the camera will shoot about 15 seconds later.
- To change the number of shots, press the   buttons after choosing  in step 1. [Blink Detection] (p. 64) is only available for the final shot.
- If no one is in the shooting area when the shutter button is pressed all the way down, the camera will shoot after a person enters the shooting area and winks.

## Using the Face Self-Timer

The camera will shoot about two seconds after detecting that the face of another person (such as the photographer) has entered the shooting area (p. 108). This is useful when including yourself in group photos or similar shots.



### 1 Choose .

- Follow steps 1 – 2 on p. 68 and choose , and then press the  button.
- Press the   buttons or turn the  dial to choose , and then press the  button.

### 2 Compose the shot and press the shutter button halfway.

- Make sure a green frame is displayed around the face you focus on and white frames around other faces.

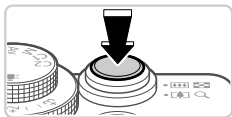

### 3 Press the shutter button all the way down.



- ▶ The camera now enters shooting standby mode, and [Look straight at camera to start count down] is displayed.
- ▶ The lamp blinks and the self-timer sound is played.



### 4 Join the subjects in the shooting area and look at the camera.

- ▶ After the camera detects a new face, the lamp blinking and self-timer sound will speed up. (When the flash fires, the lamp will remain lit.) About two seconds later, the camera will shoot.
- To cancel shooting after you have triggered the self-timer, press the **MENU** button.



- Even if your face is not detected after you join the others in the shooting area, the camera will shoot about 15 seconds later.
- To change the number of shots, press the   buttons after choosing  in step 1. [Blink Detection] (p. 64) is only available for the final shot.

## High-Speed Continuous Shooting (High-speed Burst HQ)

You can shoot a series of shots in rapid succession by holding the shutter button all the way down. For details on continuous shooting speed, and maximum number of continuous shots, see “Continuous Shooting Speed” (see “Specifications” in the *Getting Started* guide).

HQ: High Quality



### 1 Choose .

- Follow steps 1 – 2 on p. 68 and choose .

### 2 Shoot.

- ▶ Hold the shutter button all the way down to shoot continuously.
- Shooting stops when you release the shutter button or reach the maximum number of shots, after which [Busy] is displayed and the shots are shown in the order you took them.



- Focus, image brightness, and color are determined by the first shot.
- The screen is blank while you are shooting.
- There may be a delay after continuous shooting before you can shoot again. Additionally, depending on the memory card, there may be a delay before you can shoot again. Speed Class 6 or higher memory cards are recommended.
- Shooting may slow down depending on shooting conditions, camera settings, and the zoom position.

## Images Displayed During Playback

Each set of images shot continuously is managed as a single group, and only the first image in that group will be displayed. To indicate that the image is part of a group,  is displayed in the upper left of the screen.



- If you erase a grouped image (p. 152), all images in the group are also erased. Be careful when erasing images.





- Grouped images can be played back individually (p. 144) and ungrouped (p. 144).
- Protecting (p. 148) a grouped image will protect all images in the group.
- Grouped images can be viewed individually when played back using Filtered Playback (p. 141) or Smart Shuffle (p. 147). In this case, images are temporarily ungrouped.
- Grouped images cannot be tagged as favorites (p. 157), edited (pp. 155 – 164), categorized (p. 158), or printed (p. 202), assigned as a start-up image (p. 170), and you cannot specify the number of copies to print (p. 210). To do these things, either view grouped images individually (p. 144) or cancel grouping (p. 144) first.

## Shooting Stitch Assist Images

Shoot a large subject by taking multiple shots at various positions, and then use the included software to combine them into a panorama.

### 1 Choose or .

- Follow steps 1 – 2 on p. 68 and choose  or .



### 2 Take the first shot.

- ▶ The first shot will determine the exposure and white balance.



### 3 Take additional shots.

- Compose the second shot so that it partially overlaps the image area of first shot.
- Minor misalignment of overlapping portions will be corrected automatically when the images are combined.
- Take up to 26 shots, the same way you took the second shot.

### 4 Finish shooting.

- Press the  button.



### 5 Use the software to combine the images.

- For instructions on merging images, refer to the *Software Guide*.





- This function is not available when using a TV as a display while shooting (p. 187).
- To use AF lock, assign AFL to the  button (p. 131).

# Shooting Various Movies

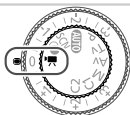
## Shooting Movies in Mode





- 1 Enter  mode.**
  - Set the mode dial to .
- 2 Configure the settings to suit the movie (pp. 226 – 234).**
- 3 Shoot.**
  - Press the movie button.
  - To stop movie recording, press the movie button again.

## Locking or Changing Image Brightness Before Shooting

Before shooting, you can lock the exposure or change it in 1/3-stop increments within a range of -2 to +2.



- 1 Lock the exposure.**
  - Press the  button to lock the exposure. The exposure shift bar is displayed.
  - To unlock the exposure, press the  button again.
- 2 Adjust the exposure.**
  - Turn the  dial to adjust the exposure, as you watch the screen.
- 3 Shoot.**





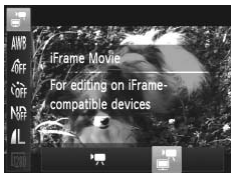

## Shooting iFrame Movies

Shoot movies that can be edited with iFrame-compatible software or devices. You can quickly edit, save, and manage iFrame movies using the included software.



### 1 Choose .

- Set the mode dial to .
- Press the  button, choose  in the menu, and then choose  (p. 40).
- ▶ Black bars displayed on the top and bottom edges of the screen indicate image areas not recorded.

### 2 Shoot.



- The resolution is  (p. 60) and cannot be changed.
- iFrame is a video format developed by Apple.



# 4

## P mode

More discerning shots, in your preferred shooting style

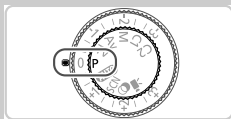

- Instructions in this chapter apply to the camera with the mode dial set to **P** mode.
- **P**: Program AE; AE: Auto Exposure
- Before using a function introduced in this chapter in modes other than **P**, make sure the function is available in that mode (pp. 226 – 233).

## Shooting in Program AE Mode (P Mode)

You can customize many function settings to suit your preferred shooting style.



### 1 Enter **P** mode.

- Set the mode dial to **P**.

### 2 Customize the settings as desired (pp. 93 – 120), and then shoot.



- If adequate exposure cannot be obtained when you press the shutter button halfway, shutter speeds and aperture values are displayed in orange. To obtain adequate exposure, try adjusting the following settings.
  - Activate the flash (p. 116)
  - Choose a higher ISO speed (p. 95)
- Movies can be recorded in **P** mode as well, by pressing the movie button. However, some **FUNC.** and **MENU** settings may be automatically adjusted for movie recording.
- For details on the shooting range in **P** mode, see “Specifications” in the *Getting Started* guide.

## Image Brightness (Exposure Compensation)

### Adjusting Image Brightness (Exposure Compensation)

The standard exposure set by the camera can be adjusted in 1/3-stop increments, in a range of -3 to +3.

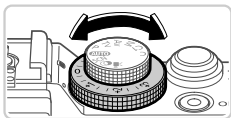

- As you watch the screen, turn the exposure compensation dial to adjust brightness.
- ▶ The correction level you specified is now displayed.



### Locking Image Brightness/Exposure (AE Lock)

Before shooting, you can lock the exposure, or you can specify focus and exposure separately.



#### 1 Lock the exposure.

- Aim the camera at the subject to shoot with the exposure locked, and then press the \* button.
- ▶ \* is displayed, and the exposure is locked.

#### 2 Compose the shot and shoot.

- After one shot, AE is unlocked and \* is no longer displayed.



- AE: Auto Exposure
- After the exposure is locked, you can adjust the combination of shutter speed and aperture value by turning the  dial (Program Shift).

## Changing the Metering Method

Adjust the metering method (how brightness is measured) to suit shooting conditions as follows.



- Press the button, turn the dial to choose the desired option, and then press the button again.
- ▶ The option you configured is now displayed.

Evaluative	For typical shooting conditions, including backlit shots. Automatically adjusts exposure to match the shooting conditions.
Center Weighted Avg.	Determines the average brightness of light across the entire image area, calculated by treating brightness in the central area as more important.
Spot	Metering restricted to within the  (Spot AE Point frame). You can also link the Spot AE Point frame to the AF frame.

## Linking the Spot AE Point Frame to the AF Frame



### 1 Set the metering method to .

- Follow the step above to choose .

### 2 Configure the setting.

- Press the **MENU** button, choose [Spot AE Point] on the tab, and then choose [AF Point] (p. 41).
- ▶ The Spot AE Point frame will now be linked to the movement of the AF frame (p. 110).



- Not available when [AF Frame] is set to [Face AiAF] (p. 108) or [Tracking AF] (p. 111).

## Changing the ISO Speed



- Press the **▲** button, choose an option (either press the **◀▶** buttons or turn the **●** dial), and then press the **FUNC SET** button.
- ▶ The option you configured is now displayed.

<b>ISO</b> AUTO	Automatically adjusts the ISO speed to suit the shooting mode and conditions.	
<b>ISO</b> 100	<b>ISO</b> 125	For shooting outdoors in fair weather.
<b>ISO</b> 160	<b>ISO</b> 200	
<b>ISO</b> 250	<b>ISO</b> 320	Low
<b>ISO</b> 400	<b>ISO</b> 500	↑
<b>ISO</b> 640	<b>ISO</b> 800	↓
<b>ISO</b> 1000	<b>ISO</b> 1250	High
<b>ISO</b> 1600	<b>ISO</b> 2000	
<b>ISO</b> 2500	<b>ISO</b> 3200	
<b>ISO</b> 4000	<b>ISO</b> 5000	
<b>ISO</b> 6400	<b>ISO</b> 8000	
<b>ISO</b> 10000	<b>ISO</b> 12800	



- To view the automatically set ISO speed when the camera is set to **ISO AUTO**, press the shutter button halfway.
- Although choosing a lower ISO speed may reduce image graininess, there may be a greater risk of subject blurriness in some shooting conditions.
- Choosing a higher ISO speed will increase shutter speed, which may reduce subject blurriness and increase the flash range. However, shots may look grainy.
- Press the **☺** button while in the setting screen to set **ISO AUTO**.

## Adjusting the Maximum **ISO AUTO** ISO Speed

Maximum ISO speed when the camera is set to **ISO AUTO** can be specified in a range of **ISO 400** – **ISO 1600**.

### 1 Access the setting screen.

- Press the **MENU** button, choose [ISO Auto Settings] on the **📷** tab, and then press the **FUNC SET** button (p. 41).

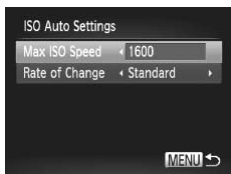

### 2 Configure the setting.

- Choose [Max ISO Speed], and then choose the desired option (p. 41).

### Adjusting <sup>ISO</sup>AUTO Sensitivity

Choose from three levels of sensitivity for <sup>ISO</sup>AUTO.

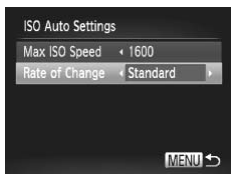

- Follow step 1 in “Adjusting the Maximum <sup>ISO</sup>AUTO ISO Speed” (p. 95) to access the setting screen.
- Choose [Rate of Change], and then choose the desired option (p. 41).



- If you press the **MENU** button while in the ISO auto settings screen (p. 95), the [ISO Auto Settings] screen will appear.

## Changing the Noise Reduction Level (High ISO NR)

You can choose from 3 levels of noise reduction: [Standard], [High], [Low]. This function is especially effective when shooting at high ISO speeds.

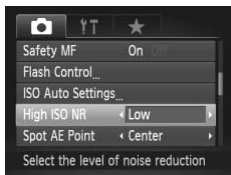

### Choose a noise reduction level.

- Press the **MENU** button, choose [High ISO NR] in the  tab, and then choose the desired option.





## Auto Exposure Bracketing (AEB Mode)

Three consecutive images are captured at different exposure levels (standard exposure, underexposure, and then overexposure) each time you shoot. You can adjust the amount of underexposure and overexposure (relative to standard exposure) from  $-2$  to  $+2$  stops in  $1/3$ -stop increments.





### 1 Choose .

- Press the  button, choose  in the menu, and then choose  (p. 40).



### 2 Configure the setting.

- Press the **MENU** button, and then adjust the setting by pressing the   buttons or turning the  dial.



- AEB is only available in  mode (pp. 22, 45).
- Continuous shooting (p. 104) is not available in this mode.



- If exposure compensation is already in use (p. 93), the value specified for that function is treated as the standard exposure level for this function.
- You can also access the setting screen of step 2 by pressing the **MENU** button when the exposure compensation screen (p. 93) is displayed.
- Three shots are taken, regardless of any quantity specified in  (p. 53).
- [Blink Detection] (p. 64) is only available for the final shot.

## Correcting Image Brightness (i-Contrast)

Before shooting, excessively bright or dark image areas (such as faces or backgrounds) can be detected and automatically adjusted to the optimal brightness.

To avoid washed-out highlights, specify Dynamic Range Correction. To preserve image detail in shadows, specify Shadow Correct.



- Under some shooting conditions, correction may be inaccurate or may cause images to appear grainy.



- You can also correct existing images (p. 163).
- You can customize camera operation so that turning the or dial adjusts DR Correction or Shadow Correct settings (p. 129).

## Dynamic Range Correction (DR Correction)

Choose from three correction methods.

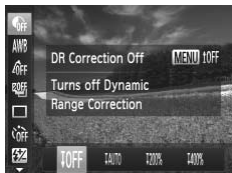

- Press the button, choose in the menu, and choose the desired option (p. 40).
- ▶ Once the setting is complete, is displayed.



- With  $\frac{1}{200\%}$  and  $\frac{1}{400\%}$ , the ISO speed will be restored to  $\frac{\text{ISO}}{1600}$  if you attempt to set a speed higher than  $\frac{\text{ISO}}{1600}$ .
- With  $\frac{1}{200\%}$ , the ISO speed will be restored to  $\frac{\text{ISO}}{200}$  if you attempt to set a speed lower than  $\frac{\text{ISO}}{200}$ .
- With  $\frac{1}{400\%}$ , the ISO speed will be restored to  $\frac{\text{ISO}}{400}$  if you attempt to set a speed lower than  $\frac{\text{ISO}}{400}$ .

## Shadow Correct



- Press the **FUNC/SET** button, choose **OFF** in the menu, press the **MENU** button, and choose **AUTO** (p. 40).
- ▶ Once the setting is complete, **Ci** is displayed.

## Using the ND Filter

To shoot at slower shutter speeds and smaller aperture values, use the ND filter, which reduces light intensity to 1/8 the actual level (equivalent to 3 stops).



- Press the **FUNC/SET** button, choose **ND** in the menu, and then choose **ND** (p. 40).









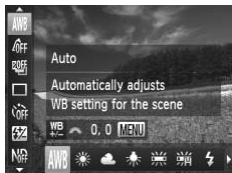



- Mount the camera on a tripod or take other measures to keep it still and prevent camera shake. In this case, set [IS Mode] to [Off] (p. 120).

## Adjusting White Balance

By adjusting white balance (WB), you can make image colors look more natural for the scene you are shooting.



- Press the  button, choose **AWB** in the menu, and choose the desired option (p. 40).
- ▶ The option you configured is now displayed.

 Auto	Automatically sets the optimal white balance for the shooting conditions.
 Day Light	For shooting outdoors in fair weather.
 Cloudy	For shooting in cloudy conditions, in the shade, or at twilight.
 Tungsten	For shooting under ordinary incandescent (tungsten) lighting and similarly colored fluorescent lighting.
 Fluorescent	For shooting under warm-white, cool-white, and similarly colored fluorescent lighting.
 Fluorescent H	For shooting under daylight fluorescent and similarly colored fluorescent lighting.
 Flash	For shooting with the flash.
 Underwater	Sets the optimal white balance for shooting underwater. Tones down blues to produce natural-looking colors overall.
 Custom	For manually setting a custom white balance (p. 101).

## Custom White Balance

For image colors that look natural under the light in your shot, adjust white balance to suit the light source where you are shooting. Set the white balance under the same light source that will illuminate your shot.

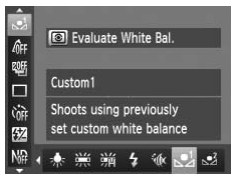

- Follow the steps in “Adjusting White Balance” (p. 100) to choose or .
- Aim the camera at a plain white subject, so that the entire screen is white. Press the button.
- ▶ The tint of the screen changes once the white balance data has been recorded.

- Colors may look unnatural if you change camera settings after recording white balance data.

## Manually Correcting White Balance

You can manually correct white balance. This adjustment can match the effect of using a commercially available color temperature conversion filter or color-compensating filter.



### 1 Configure the setting.

- Follow the steps in “Adjusting White Balance” (p. 100) to choose the white balance option.
- Turn the dial to adjust the correction level for B and A.



### 2 Configure advanced settings.

- To configure more advanced settings, press the **MENU** button and turn the or dial to adjust the correction level.
- To reset the correction level, press the button.
- Press the **MENU** button to complete the setting.

-  The camera will retain white balance correction levels even if you switch to another white balance option in step 1, but correction levels will be reset if you record custom white balance data.



- B: blue; A: amber; M: magenta; G: green
- One level of blue/amber correction is equivalent to about 7 mireds on a color temperature conversion filter. (Mired: Color temperature unit representing color temperature conversion filter density)
- You can customize camera operation so that the B and A adjustment screen can be accessed simply by turning the  dial (p. 129).





Still Images



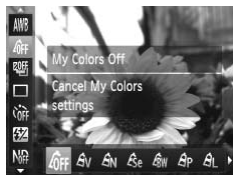





Movies





## Changing Image Color Tones (My Colors)





Change image color tones as desired, such as converting images to sepia or black and white.



-  Press the  button, choose  in the menu, and choose the desired option (p. 40).
-  The option you configured is now displayed.

 My Colors Off	—
 Vivid	Emphasizes contrast and color saturation, making images sharper.
 Neutral	Tones down contrast and color saturation for subdued images.
 Sepia	Creates sepia tone images.
 B/W	Creates black and white images.
 Positive Film	Combines the effects of Vivid Blue, Vivid Green, and Vivid Red to produce intense yet natural-looking colors resembling images on positive film.
 Lighter Skin Tone	Lightens skin tones.
 Darker Skin Tone	Darkens skin tones.

 Vivid Blue	Emphasizes blues in images. Makes the sky, ocean, and other blue subjects more vivid.
 Vivid Green	Emphasizes greens in images. Makes mountains, foliage, and other green subjects more vivid.
 Vivid Red	Emphasizes reds in images. Makes red subjects more vivid.
 Custom Color	Adjust contrast, sharpness, color saturation, and other qualities as desired (see below).

-  • White balance (p. 100) cannot be set in  or  modes.
- With  and  modes, colors other than people's skin tone may be modified. These settings may not produce the expected results with some skin tones.

## ■ Custom Color



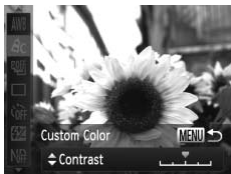

Choose the desired level of image contrast, sharpness, color saturation, red, green, blue, and skin tones in a range of 1 – 5.



### 1 Access the setting screen.

- Follow the steps in “Changing Image Color Tones (My Colors)” (p. 102) to choose , and then press the **MENU** button.

### 2 Configure the setting.

- Press the   buttons to choose an option, and then specify the value by pressing the   buttons or turning the  dial.
- For stronger/more intense effects (or darker skin tones), adjust the value to the right, and for weaker/lighter effects (or lighter skin tones), adjust the value to the left.
- Press the **MENU** button to complete the setting.

## Continuous Shooting

Hold the shutter button all the way down to shoot continuously.









### 1 Configure the setting.

- Press the  button, choose  in the menu, and choose the desired option (p. 40).
- ▶ The option you configured is now displayed.

### 2 Shoot.

- ▶ Hold the shutter button all the way down to shoot continuously.

Mode	Description
 Continuous	Continuous shooting, with the focus and exposure determined when you press the shutter button halfway.
 Continuous Shooting AF	Continuous shooting and focusing. [AF Frame] is set to [Center] and cannot be changed.
 Continuous Shooting LV*	Continuous shooting, with the focus fixed at the position determined in manual focusing. In  mode, focus is determined by the first shot.

\* In  mode (p. 70), AF lock (p. 114), or manual focus mode (p. 106),  is changed to .

\* For details on the continuous shooting speed in each mode, see “Specifications” in the *Getting Started* guide.



- Cannot be used with the self-timer (p. 52) or [Blink Detection] (p. 64).
- Shooting may stop momentarily or continuous shooting may slow down depending on shooting conditions, camera settings, and the zoom position.
- As more shots are taken, shooting may slow down.
- Shooting may slow down if the flash fires.



# Shooting Range and Focusing

Still Images

Movies



## Shooting at Preset Focal Lengths (Step Zoom)

You can shoot at preset focal lengths of 28 mm, 35 mm, 50 mm, 85 mm, 100 mm or 112 mm (35mm film equivalents). This is convenient when you want to shoot at the angle of view of those focal lengths.

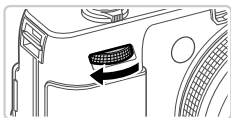
### 1 Assign ZOOM to the dial (p. 128).





### 2 Choose a focal length.

- Turn the  dial clockwise until it clicks to change the focal length from 28 mm to 35 mm. Keep turning the  dial to increase the focal length, which changes to 50 mm, 85 mm, 100 mm, and 112 mm at each click.



- Step zoom is not available when shooting movies even if you turn the  dial.









- When using the digital zoom (p. 51), turning the  dial clockwise will not change the zoom factor. However, turning the  dial counterclockwise will set the focal length to 112 mm.

Still Images

## Shooting Close-ups (Macro)

To restrict the focus to subjects at close range, set the camera to . For details on the focusing range, see “Specifications” in the *Getting Started* guide.



- Press the  button, choose  (either press the  buttons or turn the  dial), and then press the  button.
- ▶ Once the setting is complete,  is displayed.



- If the flash fires, vignetting may occur.
- Be careful to avoid damaging the lens.
- In the yellow bar display area below the zoom bar,  will turn gray and the camera will not focus.



- To prevent camera shake, try mounting the camera on a tripod and shooting with the camera set to  (p. 53).

Still Images





Movies

## Shooting in Manual Focus Mode

When focusing is not possible in AF mode, use manual focus. You can specify the general focal position and then press the shutter button halfway to have the camera determine the optimal focal position near the position you specified. For details on the focusing range, see “Specifications” in the *Getting Started* guide.



### 1 Choose MF.

- Press the  button, choose **MF** (either press the   buttons or turn the  dial), and then press the  button.
- ▶ **MF** and the MF indicator are displayed.



MF Indicator

### 2 Specify the general focal position.



- Referring to the on-screen MF indicator bar (which shows the distance and focal position) and the magnified display area, turn the  dial to specify the general focal position.

### 3 Fine-tune the focus.

- Press the shutter button halfway to have the camera fine-tune the focal position (Safety MF).
- You can also fine-tune the focus by pressing the  button.

- ❗ AF frame mode or size cannot be changed while focusing manually (p. 108). If you want to change the AF frame mode or size, cancel manual focus mode first.
- Focusing is possible when using the digital zoom (p. 51) or digital tele-converter, or when using a TV as a display (p. 187), but the magnified display will not appear.



- To focus more accurately, try attaching the camera to a tripod to stabilize it.
- To hide the magnified display area, press the **MENU** button and set [MF-Point Zoom] on the  tab to [Off] (p. 41).
- To deactivate automatic focus fine-tuning when the shutter button is pressed halfway, press the **MENU** button and set [Safety MF] on the  tab to [Off] (p. 41).

Still Images

Movies

## Digital Tele-Converter

The focal length of the lens can be increased by approximately 1.5x or 1.9x. This can reduce camera shake because the shutter speed is faster than it would be if you zoomed (including using digital zoom) in to the same zoom factor.



- Press the **MENU** button, choose [Digital Zoom] on the  tab, and then choose the desired option (p. 41).
- ▶ The view is enlarged and the zoom factor is displayed on the screen.

- ❗ Images will look grainy at a resolution (p. 57) of **L** or **M1**. In this case, the zoom factor is shown in blue.
- The digital tele-converter cannot be used with digital zoom (p. 51) and AF-point zoom (p. 63).
- The digital tele-converter is only available when the aspect ratio is 4:3.



- The respective focal lengths when using [1.5x] and [1.9x] are 42.0 – 168 mm and 53.2 – 213 mm (35mm film equivalent).
- The shutter speed may be equivalent when you move the zoom lever all the way toward [L] for maximum telephoto, and when you zoom in to enlarge the subject to the same size following step 2 on p. 51.

Still Images

Movies

### Changing the AF Frame Mode

Change the AF (auto focus) frame mode to suit the shooting conditions as follows.



- Press the **MENU** button, choose [AF Frame] on the  tab, and then choose the desired option (p. 41).

Still Images

Movies

### Face AiAF

- Detects people's faces, and then sets the focus, exposure (evaluative metering only), and white balance (**AWB** only).
- After you aim the camera at the subject, a white frame is displayed around the person's face determined by the camera to be the main subject, and up to two gray frames are displayed around other detected faces.
- When the camera detects movement, frames will follow moving subjects, within a certain range.
- After you press the shutter button halfway, up to nine green frames are displayed around faces in focus.

- ❗ If faces are not detected, or when only gray frames are displayed (without a white frame), up to nine green frames are displayed in the areas in focus when you press the shutter button halfway.
- If faces are not detected when Servo AF (p. 112) is set to [On], the AF frame is displayed in the center of the screen when you press the shutter button halfway.
- Examples of faces that cannot be detected:
  - Subjects that are distant or extremely close
  - Subjects that are dark or light
  - Faces in profile, at an angle, or partly hidden
- The camera may misinterpret non-human subjects as faces.
- No AF frames are displayed if the camera cannot focus when you press the shutter button halfway.

Still Images

### FlexiZone/Center

One AF frame is displayed. Effective for reliable focusing. With [FlexiZone], you can move and resize the AF frame (p. 110).

- ❗ A yellow AF frame is displayed with  if the camera cannot focus when you press the shutter button halfway. Note that AF-point zooming (p. 63) is not possible.

Still Images

### Recomposing Shots While the Focus is Locked

As long as you keep the shutter button pressed halfway, the focus and exposure are locked. You can recompose shots as needed before shooting. This feature is called Focus Lock.



#### 1 Focus.

- Aim the camera so that the subject is centered, and then press the shutter button halfway.
- Confirm that the AF frame displayed around the subject is green.



### 2 Recompose the shot.

- Keeping the shutter button pressed halfway, move the camera to recompose the shot.

### 3 Shoot.

- Press the shutter button all the way down.

Still Images







## Moving and Resizing AF Frames (FlexiZone)

When you want to change the position or size of the AF frame, set the AF frame mode to [FlexiZone] (p. 109).

### 1 Prepare to move the AF frame.

- Press the  button. The AF frame turns orange.

### 2 Move and resize the AF frame.

- Turn the  dial to move the AF frame, or press the     buttons to move it by a smaller amount.
- To return the AF frame to the original position in the center, keep the  button held down.
- To reduce the AF frame size, press the **MENU** button. Press it again to restore it to the original size.

### 3 Complete the settings.

- Press the  button.



- AF frames are displayed at normal size when you use the digital zoom (p. 51) or digital tele-converter (p. 107), and in manual focus mode (p. 106).



- You can also link the Spot AE Point frame to the AF frame (p. 94).

## Choosing Subjects to Focus On (Tracking AF)



Shoot after choosing a subject to focus on as follows.

### 1 Choose [Tracking AF].



- Follow the steps in “Changing the AF Frame Mode” (p. 108) to choose [Tracking AF].
- ▶  is displayed in the center of the screen.





### 2 Choose a subject to focus on.

- Aim the camera so that  is on the desired subject, and then press the  button.





- ▶ When the subject is detected, the camera beeps and  is displayed. Even if the subject moves, the camera will continue to track the subject within a certain range.
- ▶ If no subject is detected,  is displayed.
- To cancel tracking, press the  button again.



### 3 Shoot.

- Press the shutter button halfway.  changes to a blue , which follows the subject as the camera continues to adjust the focus and exposure (Servo AF) (p. 112).
- Press the shutter button all the way down to shoot.
- ▶ Even after your shot,  is still displayed and the camera continues to track the subject.



- [Servo AF] is set to [On] and cannot be changed.
- Tracking may not be possible when subjects are too small or move too rapidly, or when subject color or brightness matches that of the background too closely.
- [AF-Point Zoom] on the  tab is not available.
-  is not available.



- The camera can detect subjects even if you press the shutter button halfway without pressing the  button. After your shot,  is displayed in the center of the screen.

## Shooting with Servo AF

This mode helps avoid missing shots of subjects in motion, because the camera continues to focus on the subject and adjust the exposure as long as you press the shutter button halfway.

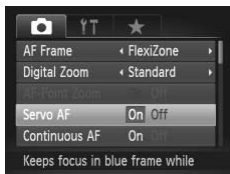

### 1 Configure the setting.

- Press the **MENU** button, choose [Servo AF] on the  tab, and then choose [On]. (p. 41).

### 2 Focus.

- The focus and exposure are maintained where the blue AF frame is displayed while you are pressing the shutter button halfway.



- Focusing may not be possible in some shooting conditions.
- In low-light conditions, Servo AF may not be activated (AF frames may not turn blue) when you press the shutter button halfway. In this case, the focus and exposure are set according to the specified AF frame mode.
- If adequate exposure cannot be obtained, shutter speeds and aperture values are displayed in orange. Release the shutter button, and then press it halfway again.
- AF lock shooting is not available.
- [AF-Point Zoom] on the  tab is not available.
- Not available when using the self-timer (p. 52).



## Changing the Focus Setting

You can change default camera operation of constantly focusing on subjects it is aimed at, even when the shutter button is not pressed. Instead, you can limit camera focusing to the moment you press the shutter button halfway.



- Press the **MENU** button, choose [Continuous AF] on the tab, and then choose [Off] (p. 41).

On	Helps avoid missing sudden photo opportunities, because the camera constantly focuses on subjects until you press the shutter button halfway.
Off	Conserves battery power, because the camera does not focus constantly.

## Choosing a Person to Focus On (Face Select)

You can shoot after choosing a specific person's face to focus on.





- 1 **Set the AF frame to [Face AiAF] (p. 108).**

- 2 **Enter Face Select mode.**

- Aim the camera at the person's face and press the button.
- ▶ After [Face Select : On] is displayed, a face frame is displayed around the face detected as the main subject.
- Even if the subject moves, the face frame follows the subject within a certain range.
- If a face is not detected, is not displayed.





### 3 Choose the face to focus on.

- To switch the face frame  to another detected face, press the  button.
- After you have switched the face frame to all detected faces, [Face Select : Off] is displayed, and the specified AF frame mode screen is displayed again.



### 4 Shoot.

- Press the shutter button halfway. After the camera focuses,  changes to .
- Press the shutter button all the way down to shoot.

Still Images





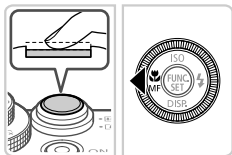

Movies

## Shooting with the AF Lock

The focus can be locked. After you lock the focus, the focal position will not change even when you release your finger from the shutter button.



### 1 Lock the focus.

- With the shutter button pressed halfway, press the  button.
- ▶ The focus is now locked, and **MF** and the MF indicator are displayed.
- To unlock the focus, after you release the shutter button, press the  button again and choose  (either press the   buttons or turn the  dial).



### 2 Compose the shot and shoot.

## Focus Bracketing (Focus-BKT Mode)

Three consecutive images are captured each time you shoot, with the first one at the focal distance you set manually and the others at farther and nearer focal positions determined by presets. The distance from your specified focus can be set in three levels.



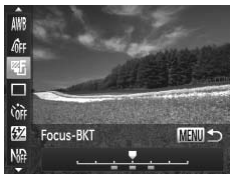

### 1 Choose .

- Press the  button, choose  in the menu, and then choose  (p. 40).





### 2 Configure the setting.

- Press the **MENU** button, and then adjust the setting by pressing the   buttons or turning the  dial.



- Focus bracketing is only available in  mode (pp. 22, 45).
- Continuous shooting (p. 104) is not available in this mode.



- You can also access the setting screen in step 2 by choosing  in step 1 on p. 106 and immediately pressing the **MENU** button.
- Three shots are taken, regardless of any quantity specified in  (p. 53).
- [Blink Detection] (p. 64) is only available for the final shot.

# Flash

## Activating Flash

You can have the flash fire for each shot. For details on the flash range, see “Flash Range” (see “Specifications” in the *Getting Started* guide).



### 1 Raise the flash.

- Move the ►⚡ switch.

### 2 Configure the setting.

- Press the ► button, choose ⚡ (either press the ◀▶ buttons or turn the ● dial), and then press the  button.
- ▶ Once the setting is complete, ⚡ is displayed.



- If the flash is lowered, the setting screen will not appear even if you press the ► button. Move the ►⚡ switch to raise the flash, then configure the setting.

## Shooting with Slow Synchro

With this option, the flash fires to increase the brightness of the main subject (such as people) while the camera shoots at a slow shutter speed to increase the brightness of the background that is out of the flash range.

For details on the flash range, see “Flash Range” (see “Specifications” in the *Getting Started* guide).

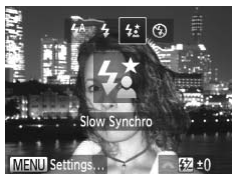

### 1 Raise the flash.

- Move the ►⚡ switch.

### 2 Configure the setting.

- Press the ► button, choose ⚡★ (either press the ◀▶ buttons or turn the ● dial), and then press the  button.
- ▶ Once the setting is complete, ⚡★ is displayed.

### 3 Shoot.

- Even after the flash fires, ensure that the main subject does not move until the shutter sound is finished playing.

- ⓘ Mount the camera on a tripod or take other measures to keep it still and prevent camera shake. In this case, set [IS Mode] to [Off] (p. 120).
- If the flash is lowered, the setting screen will not appear even if you press the **▶** button. Move the **▶⚡** switch to raise the flash, then configure the setting.

## Adjusting the Flash Exposure Compensation

Just as with regular exposure compensation (p. 93), you can adjust the flash exposure from -2 to +2 stops, in 1/3-stop increments.

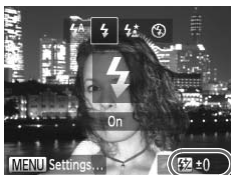

- Raise the flash, press the **▶** button and immediately turn the dial to choose the compensation level, and then press the **FUNC SET** button.
- ▶ Once the setting is complete, is displayed.



- When there is a risk of overexposure, the camera automatically adjusts the shutter speed or aperture value during the flash shots to reduce washed-out highlights and shoot at optimal exposure. However, you can deactivate automatic adjustment of the shutter speed and aperture value by accessing **MENU** (p. 41) and setting [Safety FE] in [Flash Control] on the tab to [Off].
- You can also configure the flash exposure compensation by choosing in the FUNC. menu (p. 40), or by accessing **MENU** (p. 41) and choosing [Flash Exp. Comp] in [Flash Control] on the tab.
- You can also access the [Built-in Flash Settings] **MENU** screen as follows (except when an external flash (sold separately) is attached to the camera).
  - Press and hold the **▶** button for at least one second.
  - When the flash is up, press the **▶** button and immediately press the **MENU** button.

## Shooting with the FE Lock

Just as with the AE lock (p. 93), you can lock the exposure for the flash shots.



**1 Raise the flash and set it to ⚡ (p. 116).**

**2 Lock the flash exposure.**

- Aim the camera at the subject to shoot with the exposure locked, and then press the \* button.
- ▶ The flash fires, and when \* is displayed, the flash output level is retained.

**3 Compose the shot and shoot.**

- After one shot, FE is unlocked and \* is no longer displayed.





• FE: Flash Exposure

## Changing the Flash Timing

Change the timing of the flash and shutter release as follows.



**1 Access the setting screen.**

- Press the **MENU** button, choose [Flash Control] on the  tab, and then press the  button (p. 41).

**2 Configure the setting.**

- Choose [Shutter Sync.], and then choose the desired option (p. 41).

1st-curtain	The flash fires immediately after the shutter opens.
2nd-curtain	The flash fires immediately before the shutter closes.

## Shooting RAW Images

RAW images are “raw” (unprocessed) data, recorded with essentially no loss of image quality from the camera’s internal image processing. Use the included software to adjust RAW images as desired with minimal loss of image quality.



- Press the  button, choose **JPEG** in the menu, and choose the desired option (p. 40).

**JPEG**

Records JPEG images. JPEG images are processed in the camera for optimal image quality and compressed to reduce file size. However, the compression process is irreversible, and images cannot be restored to their original, unprocessed state. Image processing may also cause some loss of image quality.

**RAW**

Records RAW images. RAW images are “raw” (unprocessed) data, recorded with essentially no loss of image quality from the camera’s image processing. The data cannot be used in this state for viewing or printing on a computer. You must first use the included software (Digital Photo Professional) to convert images to ordinary JPEG or TIFF files. Images can be adjusted with minimal loss of image quality. For details on resolution and the number of shots that will fit on a card, see “Specifications” in the *Getting Started* guide.

**RAW+JPEG**

Records two images, both a RAW image and a JPEG image, for each shot. The JPEG image can be printed or viewed on a computer without using the included software.



- When transferring RAW images (or RAW and JPEG images recorded together) to a computer, always use the included software (p. 26).
- Digital zoom (p. 51), date stamps (p. 54), and red-eye reduction (p. 58) are set to [Off] in **RAW** and **RAW+JPEG** modes. Additionally, i-Contrast (p. 163), My Colors (p. 102) and noise reduction level (p. 96) settings are not available.



- The aspect ratio setting (p. 56) is only applied to JPEG images. RAW images are always shot at an aspect ratio of 4:3.
- To erase **RAW+JPEG** images, display the **RAW+JPEG** image and press  button (p. 152). Choose from [Erase **RAW**], [Erase JPEG], or [Erase **RAW+JPEG**] to erase the image.
- The file extension for JPEG images is .JPG, and the extension for RAW images is .CR2.

## Changing the IS Mode Settings

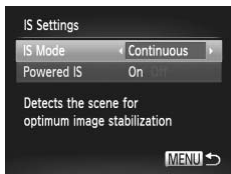

### 1 Access the setting screen.

- Press the **MENU** button, choose [IS Settings] on the tab, and then press the button (p. 41).

### 2 Configure the setting.

- Choose [IS Mode], and then choose the desired option (p. 41).

Continuous	Optimal image stabilization for the shooting conditions is automatically applied (Intelligent IS) (p. 49).
Shoot Only*	Image stabilization is active only at the moment of shooting.
Off	Deactivates image stabilization.

\*The setting is changed to [Continuous] for movie recording.



- If image stabilization cannot prevent camera shake, mount the camera on a tripod or take other measures to hold it still. In this case, set [IS Mode] to [Off].



## Deactivating Powered IS

Powered IS reduces slow camera shake that may occur when recording telephoto movies. However, this option may not produce the expected results when used for the stronger camera shake that may occur when shooting while walking or when moving the camera to match subject movement. In this case, set Powered IS to [Off].

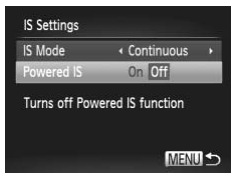

- Follow the steps in “Changing the IS Mode Settings” (p. 120) to access the [IS Settings] screen.
- Choose [Powered IS], and then choose [Off] (p. 41).

ⓘ • [Powered IS] settings are not applied when [IS Mode] is set to [Off].



# 5

## Tv, Av, M, C1, C2 Mode

Take smarter, more sophisticated shots, and customize the camera for your shooting style

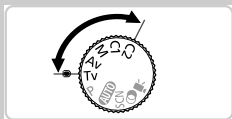

- Instructions in this chapter apply to the camera as set to the respective mode.

## Specific Shutter Speeds (Tv Mode)

Set your preferred shutter speed before shooting as follows. The camera automatically adjusts the aperture value to suit your shutter speed. For details on available shutter speeds, see “Specifications” in the *Getting Started* guide.



### 1 Enter **Tv** mode.

- Set the mode dial to **Tv**.

### 2 Set the shutter speed.

- Turn the  dial to set the shutter speed.



- With slow shutter speeds, there will be a delay before you can shoot again, as the camera processes images to reduce noise.
- When shooting at low shutter speeds on a tripod, you should set [IS Mode] to [Off] (p. 120).
- Maximum shutter speed with the flash is 1/2000 second. If you specify a faster speed, the camera will automatically reset the speed to 1/2000 second before shooting.
- Orange display of aperture values when you press the shutter button halfway indicates that the settings deviate from standard exposure. Adjust the shutter speed until the aperture value is displayed in white, or use safety shift (p. 125).



- **Tv**: Time value
- You can customize camera operation so that turning the  dial changes the shutter speed (p. 129).

## Specific Aperture Values (Av Mode)

Set your preferred aperture value before shooting as follows. The camera automatically adjusts the shutter speed to suit your aperture value. For details on available aperture values, see “Specifications” in the *Getting Started* guide.



### 1 Enter **Av** mode.



- Set the mode dial to **Av**.

### 2 Set the aperture value.

- Turn the  dial to set the aperture value.

-  Orange display of shutter speeds when you press the shutter button halfway indicates that the settings deviate from standard exposure. Adjust the aperture value until the shutter speed is displayed in white, or use safety shift (see below).



- **Av**: Aperture value (size of the opening made by the iris in the lens)
- To avoid exposure problems in **Tv** and **Av** modes, you can have the camera automatically adjust the shutter speed or aperture value, even when standard exposure cannot otherwise be obtained. Press the **MENU** button and set [Safety Shift] on the  tab to [On] (p. 41). However, safety shift is disabled when the flash fires.
- You can customize camera operation so that turning the  dial changes the aperture value (p. 129).

## Specific Shutter Speeds and Aperture Values (M Mode)



Follow these steps before shooting to set your preferred shutter speed and aperture value to obtain the desired exposure.

For details on available shutter speeds and aperture values, see “Specifications” in the *Getting Started* guide.



### 1 Enter **M** mode.

- Set the mode dial to **M**.

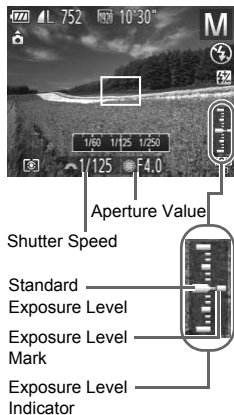

### 2 Configure the setting.

- Turn the  dial to set the shutter speed, and turn the  dial to set the aperture value.
  - ▶ An exposure level mark based on your specified value is shown on the exposure level indicator for comparison to the standard exposure level.
  - ▶ The exposure level mark is shown in orange when the difference from standard exposure exceeds 2 stops. “-2” or “+2” is displayed in orange in the lower right when you press the shutter button halfway.



- ⓘ After you set the shutter speed or aperture value, the exposure level may change if you adjust the zoom or recompose the shot.
- Screen brightness may change depending on your specified shutter speed or aperture value. However, screen brightness remains the same when the flash is up and the mode is set to .
- To have both the shutter speed and aperture value automatically adjusted to obtain standard exposure, hold the shutter button halfway and press the  button. Note that standard exposure may not be possible with some settings.



- **M**: Manual
- Calculation of standard exposure is based on the specified metering method (p. 94).
- You can customize camera operation so that turning the  dial changes shutter speed and turning the  dial changes the aperture value (p. 129).





## Adjusting the Flash Output

Choose from the three flash levels in **M** mode.





### 1 Enter **M** mode.

- Set the mode dial to **M**.

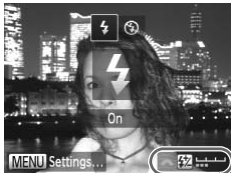
### 2 Configure the setting.

- Raise the flash, press the  button and immediately turn the  dial to choose the flash output level, then press the  button.
- ▶ Once the setting is complete,  is displayed.



- You can also set the flash level by choosing  in the FUNC. menu (p. 40), or by accessing **MENU** (p. 41) and choosing [Flash Output] in [Flash Control] on the  tab.
- You can set the flash level in **Tv** or **Av** mode by accessing **MENU** (p. 41), choosing [Flash Control] on the  tab, and then setting [Flash Mode] to [Manual].
- You can also access the [Built-in Flash Settings] **MENU** screen as follows (except when an external flash (sold separately) is attached to the camera).
  - Press and hold the  button for at least one second.
  - When the flash is up, press the  button and immediately press the **MENU** button.

## Customizing Display Information

Customize what information is shown in various display modes (switched by pressing the **▼** button), and whether or not the information is shown on the LCD monitor or viewfinder.



### 1 Access the setting screen.

- Press the **MENU** button, choose [Custom Display] on the **Ⓜ** tab, and then press the **FUNC SET** button (p. 41).

### 2 Configure the setting.

- Press the **▲▼◀▶** buttons or turn the **DISP** dial to choose an item, and then press the **FUNC SET** button. Items you choose for display are labeled with **✓**.
- In [LCD/Viewfinder] (p. 39), you can specify to show or hide this information in LCD monitor or viewfinder display modes (switched by pressing the **▼** button). Press the **▲▼◀▶** buttons or turn the **DISP** dial to choose the screen (**L**, **V**, or **L/V**), and then press the **FUNC SET** button. To hide this information in the display mode (accessed by pressing the **▼** button), add **○** to the icon. Note that the current display mode cannot be modified.
- ▶ Selected items (labeled with a **✓**) will be included in display.

Shooting Info	Displays shooting information (p. 222).
Grid Lines	Displays a reference grid.
Electronic Level	Displays the electronic level (p. 62).
Histogram	Displays a histogram (p. 138), in <b>P</b> , <b>Tv</b> , <b>Av</b> , and <b>M</b> modes.



- ⓘ Settings will not be saved if you press the shutter button halfway and return to the shooting screen from the custom display settings screen.
- Grayed-out items can also be specified, but they may not be displayed in some shooting modes.



- Grid lines are not recorded in your shots.

Still Images

Movies

## Assigning Functions to the Front Dial and Control Dial

Assign commonly used functions to the front dial and control dial, by shooting mode.



### 1 Access the setting screen.







- Press the **MENU** button, choose [Set Func.] on the tab, and then press the button (p. 41).

### 2 Configure the setting.

- Press the buttons to choose an item.
- To configure the settings, press the buttons, choose an item (either press the buttons or turn the dial), and then turn the dial to change the function.



## Assignable Functions

Functions you can assign to the front dial and control dial vary depending on shooting mode. On the setting screen, you can assign aspect ratio switching (p. 56), white balance correction (p. 100), step zoom (p. 105), or i-Contrast (p. 163) to modes indicated by ★ in the following table.

Item		Shooting Mode			
		M	Av	Tv	P
Front Dial 1		Tv	Av	Tv	★
		Av, ★	★	★	★
Front Dial 2		Av	Av	Tv	★
		Tv, ★	★	★	★
Control Dial		★	★	★	★
		Tv, Av	Av	Tv	★

• **Av**: aperture value (p. 125); **Tv**: shutter speed (p. 124)





• When multiple functions are assigned to the  dial, press the  button to switch between them.







## Assigning Functions to the Button



### 1 Access the setting screen.

- Press the **MENU** button, choose [Set Shortcut button] on the  tab, and then press the  button (p. 41).











### 2 Configure the setting.

- Press the     buttons or turn the  dial to choose a function to assign, and then press the  button.

### 3 Use the assigned function as needed.

- Press the  button to activate the assigned function.



- To restore default settings, choose .
- Icons labeled with  indicate that the function is not available in the current shooting mode or under current function conditions.
- When the  or  function is used, each press of the  button records white balance data (p. 101), and the white balance settings change to  or .
- When the **AFL** function is used, each press of the  button adjusts and locks the focus, and **AFL** is displayed on the screen.
- Pressing the  button when the  function is used deactivates screen display. To restore the display, do any of the following.
  - Press any button (other than the power button)
  - Hold the camera in another orientation
  - Open and close the screen
  - Raise and lower the flash

## Saving Shooting Settings



Save commonly used shooting modes and your configured function settings for reuse. To access saved settings later, simply turn the mode dial to **C1** or **C2**. Even settings that are usually cleared when you switch shooting modes or turn the camera off (such as self-timer settings) can be retained this way.

### Settings that can be saved





- Shooting modes (**P**, **Tv**, **Av**, and **M**)
- Items set in **P**, **Tv**, **Av**, or **M** modes (pp. 93 – 126)
- Shooting menu settings
- Zoom positions
- Manual focus positions (p. 106)
- My Menu settings (p. 133)

**1 Enter a shooting mode with settings you want to save, and change the settings as desired.**

**2 Configure the setting.**

- Press the **MENU** button, choose [Save Settings] on the  tab, and then press the  button.

**3 Save the settings.**

- Press the   buttons or turn the  dial to choose the destination, and then press the  button.

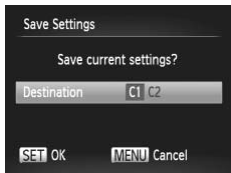
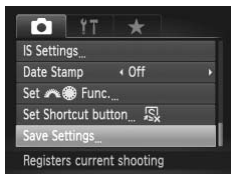

- To edit saved settings (except their shooting mode), choose **C1** or **C2**, change the settings, and then repeat steps 2 – 3. These setting details are not applied in other shooting modes.



- To clear information you have saved to **C1** or **C2** and restore default values, turn the mode dial to **C1** or **C2** and choose [Reset All] (p. 179).

Still Images

Movies

## Saving Commonly Used Shooting Menus (My Menu)

Save up to five commonly used shooting menus as menus on the ★ tab, for instant access to all of these items from a single screen.

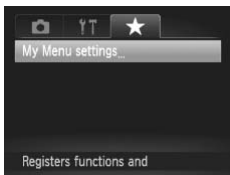



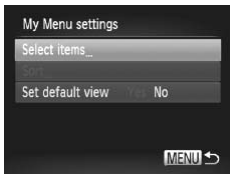

### 1 Access the setting screen.

- Press the **MENU** button, choose [My Menu settings] on the ★ tab, and then press the  button (p. 41).







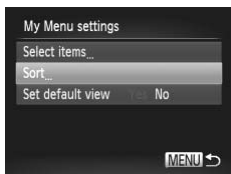

### 2 Configure the setting.

- Press the ▲▼ buttons or turn the  dial to choose [Select items], and then press the  button.
- Press the ▲▼ buttons or turn the  dial to choose menus to save (up to five), and then press the  button.
  - ▶ ✓ is displayed.
- To cancel saving, press the  button. ✓ is no longer displayed.
- Press the **MENU** button.



### 3 Rearrange the menu list order, as needed.

- Press the ▲▼ buttons or turn the  dial to choose [Sort], and then press the  button.
- Press the ▲▼ buttons or turn the  dial to choose a menu to move, and then press the  button.
- Press the ▲▼ buttons or turn the  dial to change the order, and then press the  button.
- Press the **MENU** button.



- Grayed-out items in step 2 can also be specified, but they may not be available in some shooting modes.



- To make My Menu immediately accessible by pressing the **MENU** button in Shooting mode, choose [Set default view] and press the ◀▶ buttons to choose [Yes].

# 6

## Playback Mode

Have fun reviewing your shots, and browse or edit them in many ways

- To prepare the camera for these operations, press the  button to enter Playback mode.



It may not be possible to play back or edit images that were renamed or already edited on a computer, or images from other cameras.

# Viewing

After shooting images or movies, you can view them on the screen as follows.

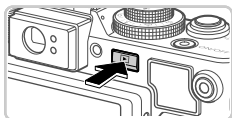

## 1 Enter Playback mode.

- Press the button.
- ▶ Your last shot is displayed.



## 2 Browse through your images.

- To view the previous image, press the button or turn the dial counterclockwise. To view the next image, press the button or turn the dial clockwise.
- Press and hold the buttons to browse through images quickly. Images appear grainy at this time.



- To access Scroll Display mode, turn the dial rapidly. In this mode, turn the dial to browse through images.
- To return to single-image display, press the button.
- To browse images grouped by shooting date, press the buttons in Scroll Display mode.
- Movies are identified by a icon. To play movies, go to step 3.







### 3 Play movies.

- To start playback, press the **FUNC SET** button to access the movie control panel, choose **▶** (either press the **◀▶** buttons or turn the **DISC** dial), and then press the **FUNC SET** button again.

### 4 Adjust the volume.

- Press the **▲▼** buttons to adjust the volume.

### 5 Pause playback.

- To pause playback, press the **FUNC SET** button. The movie control panel is displayed. To resume playback, press the **◀▶** buttons or turn the **DISC** dial to choose **▶**, and then press the **FUNC SET** button.
- ▶ After the movie is finished, **SET** **⏏** is displayed.



- To switch to Shooting mode from Playback mode, press the shutter button halfway.
- To deactivate Scroll Display, press the **MENU** button, choose [Scroll Display] on the **▶** tab, and then choose [Off].
- For playback from the last image viewed, press the **MENU** button, choose [Resume] on the **▶** tab, and then [Last seen].
- To change the transition shown between images, press the **MENU** button, choose [Transition] on the **▶** tab, and then press the **◀▶** buttons to choose the effect.

## Switching Display Modes

Press the **▼** button to view other information on the screen, or to hide the information. For details on the information displayed, see p. 222.

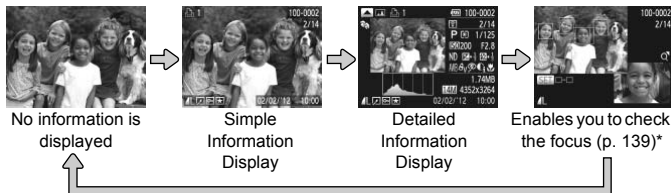

\*Not shown for movies.



- Switching display modes by pressing the **▼** button is also possible immediately after you shoot, while your shot is displayed. However, simple information display is not available. To change the initial display mode, press the **MENU** button and choose [Review Info] on the **📷** tab (p. 66).

## Overexposure Warning (for Image Highlights)

Washed-out highlights in the image flash on the screen in detailed information display.

## Histogram

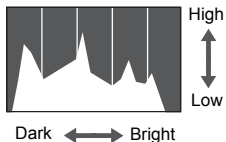

- The graph in detailed information display is a histogram showing the distribution of brightness in the image. The horizontal axis represents the degree of brightness, and the vertical axis, how much of the image is at each level of brightness. Viewing the histogram is a way to check exposure.
- The histogram can also be accessed while shooting (pp. 128, 224).

## RGB Histogram

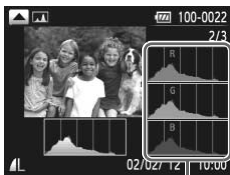

RGB Histogram

- To view an RGB histogram, press the ▲ button in detailed information display. The RGB histogram shows the distribution of shades of red, green, and blue in an image. The horizontal axis represents R, G, or B brightness, and the vertical axis, how much of the image is at that level of brightness. Viewing this histogram enables you to check image color characteristics.
- Press the ▲ button again to return to detailed information display.

## Checking the Focus

To check the focus of your shots, you can magnify the area of the image that was in the AF frame at the time of shooting.



### 1 Access Focus Check.

- Press the ▼ button (p. 138).
- A white frame is displayed where the AF frame was when the focus was set.
- Gray frames are displayed over faces detected later, in Playback mode.
- The portion of the image in the orange frame is magnified.



### 2 Switch frames.

- Move the zoom lever toward Q once.
- The screen at left is displayed.
- To switch to a different frame when there are multiple frames, press the  button.

### 3 Zoom in or out, or view other image areas.

- As you examine the focus, use the zoom lever to zoom in or out. Press the ▲▼◀▶ buttons to adjust the display position.
- Press the **MENU** button to restore the original display in step 1.

# Browsing and Filtering Images

Still Images



Movies

## Navigating Through Images in an Index

By displaying multiple images in an index, you can quickly find the images you are looking for.







### 1 Display images in an index.

- Move the zoom lever toward  to display images in an index. Moving the lever again will increase the number of images shown.
- To display fewer images, move the zoom lever toward . Fewer images are shown each time you move the lever.



### 2 Choose an image.







- Turn the  dial to scroll through the images.
- Press the    buttons to choose an image.
- ▶ An orange frame is displayed around the selected image.
- Press the  button to view the selected image in single-image display.

Still Images

Movies

## Filtering Image Display

To find images on a memory card full of images, you can filter image display, restricting display to images matching a specific filter. You can also protect (p. 148) or erase (p. 152) sets of filtered images all at once.









 Jump to Favorites	Displays images tagged as favorites (p. 157).
 Jump Shot Date	Displays the images shot on a specific date.
 Jump to My Category	Displays the images of a specific category (p. 158).
 Jump to Still/Movie	Displays still images, movies, or movies shot in  mode (p. 81).
 Jump 10 Images	Jumps by 10 images at a time.
 Jump 100 Images	Jumps by 100 images at a time.

## Filtering Display by , , , or









Filter Conditions

### 1 Choose filter conditions.

- In single-image display, press the  button, and then press the   buttons to choose a search filter (jump method).
- When filtering by , , or , press the   buttons to choose a filter condition. Turn the  dial to view only those images that match your filter conditions.
- Press the **MENU** button to restore single-image display.

### 2 View the filtered images.

- Press the  button to start browsing filtered images. The jump method and a yellow frame are displayed.
- To view images filtered by your chosen condition, press the   buttons or turn the  dial.
- Pressing the  button will display [Filtered playback settings cleared]. To cancel filtered playback, press the .



- When the camera has found no corresponding images for some filters, those filters will not be available.



- Options for viewing filtered images (step 2) include “Navigating Through Images in an Index” (p. 141), “Viewing Slideshows” (p. 146), and “Magnifying Images” (p. 145). You can protect, erase, or print all filtered images at once by choosing “All Filtered Images” in “Protecting Images” (p. 148), “Erasing All Images” (p. 152), or “Adding Images to Print Orders (DPOF)” (p. 208).
- If you recategorize images (p. 158) or edit them and save them as new images (p. 160), a message is displayed and filtered playback ends.

## Jumping by 10 or 100 Images



- Choose a jump method in single-image display by pressing the button and then pressing the buttons.
- Press the buttons to use the specified jump method.
- Press the **MENU** button to restore single-image display.

## Using the Front Dial to Jump

Turn the front dial to jump images using the , , and functions.



- Choose a jump method in single-image display by turning the dial and then pressing the buttons.
- Turn the dial to use the specified jump method.



- Turning the dial when browsing images in index display will jump to the previous or next image according to the jump method chosen in single-image display. However, if you have chosen or , the jump method will be switched to .

## Movies

### Viewing Movie Digest Movies

Movies created in mode (p. 81) can be viewed by date.



#### 1 Choose a movie.

- Press the **MENU** button to choose [Movie Digest Playback] in the tab, then choose a date.

#### 2 Play the movie.





- Press the button to start playback.

## Viewing Individual Images in a Group

Grouped images shot in  mode (p. 85) are generally displayed together, but they can also be viewed individually.







### 1 Choose an image group.

- Press the   buttons or turn the  dial to choose an image labeled , and then press the  button.



### 2 View individual images in the group.

- Pressing the   buttons or turning the  dial will display only images in the group.
- Pressing the  button will display [Display all images]. Press  to cancel group playback.



- During group playback (step 2), you can browse through images quickly (“Navigating Through Images in an Index” (p. 141)) and magnify them (“Magnifying Images” (p. 145)). You can protect, erase, or print all images in a group at once by choosing “All Images in Group” in “Protecting Images” (p. 148), “Erasing All Images” (p. 152), or “Adding Images to Print Orders (DPOF)” (p. 208).
- To ungroup images so that you can view them individually, press the **MENU** button, choose [Group Images] on the  tab, and then choose [Off] (p. 41). However, grouped images cannot be ungrouped during individual playback.



## Magnifying Images



Approximate Position of Displayed Area

### 1 Magnify an image.

- Moving the zoom lever toward **Q** will zoom in and magnify the image. You can magnify images up to about 10x by continuing to hold the zoom lever.
- To zoom out, move the zoom lever toward **Q**. You can return to single-image display by continuing to hold it.

### 2 Move the display position and switch images as needed.

- To move the display position, press the **▲▼◀▶** buttons.
- To switch to other images while zoomed, turn the **DISP** dial.



- You can return to single-image display from magnified display by pressing the **MENU** button.

## Viewing Slideshows

Automatically play back images from a memory card as follows.

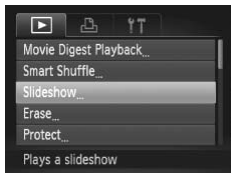

### 1 Access the setting screen.

- Press the **MENU** button and choose [Slideshow] on the tab (p. 41).

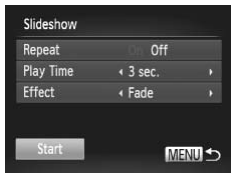

### 2 Configure the setting.

- Choose a menu item to configure, and then choose the desired option (p. 41).

### 3 Start automatic playback.

- Press the buttons or turn the dial to choose [Start], and then press the button.
  - ▶ The slideshow will start a few seconds after [Loading image...] is displayed.
- Press the **MENU** button to stop the slideshow.



- The camera's power-saving functions (p. 36) are deactivated during slideshows.





- To pause or resume slideshows, press the .
- You can switch to other images during playback by pressing the buttons or turning the dial. For fast-forward or fast-rewind, hold the buttons down.
- [Play Time] cannot be modified when [Bubble] is chosen in [Effect].
- You can also start slideshows from single-image display by pressing and holding the and immediately pressing the .

## Auto Playback of Similar Images (Smart Shuffle)

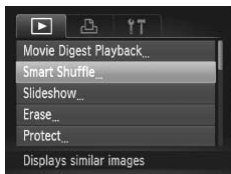
Based on the current image, the camera offers four images similar to it that you may wish to view. After you choose to view one of those images, the camera offers four more images. This is an enjoyable way to play back images in an unexpected order. Try this feature after you have taken many shots, in many kinds of scenes.







### 1 Choose Smart Shuffle.

- Press the **MENU** button, choose [Smart Shuffle] on the  tab, and then press the  button (p. 41).
- ▶ Four candidate images are displayed.



### 2 Choose an image.

- Press the    buttons to choose the image you want to view next.
- ▶ Your chosen image is displayed in the center, surrounded by the next four candidate images.
- For full-screen display of the center image, press the  button. To restore the original display, press the  button again.
- Press the **MENU** button to restore single-image display.

- ❗ Only still images shot with this camera are played back using Smart Shuffle.
- [Smart Shuffle] is not available in the following cases:
  - There are less than 50 shots taken with this camera
  - An unsupported image is currently displayed
  - The current image is being played in filtered playback

# Protecting Images

Protect important images to prevent accidental erasure by the camera (pp. 152).

## Choosing a Selection Method



### 1 Access the setting screen.

- Press the **MENU** button, and then choose [Protect] on the tab (p. 41).

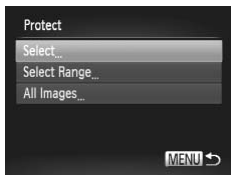

### 2 Choose a selection method.

- Choose a menu item and a setting as desired (p. 41).
- To return to the menu screen, press the **MENU** button.



- Protected images on a memory card will be erased if you format the card (pp. 171, 172).



- Protected images cannot be erased by the camera. To erase them, cancel protection settings first.







## Choosing Images Individually

### 1 Choose [Select].

- Following step 2 on p. 148, choose [Select] and press the  button.





### 2 Choose an image.

- Press the  buttons or turn the  dial to choose an image, and then press the  button.  is displayed.
- To cancel protection, press the  button again.  is no longer displayed.
- Repeat this process to specify other images.



### 3 Protect the images.

- Press the **MENU** button. A confirmation message is displayed.
- Press the  buttons or turn the  dial to choose [OK], and then press the  button.

- ⓘ Images will not be protected if you switch to Shooting mode or turn the camera off before finishing the setup process in step 3.

## Selecting a Range

### 1 Choose [Select Range].





- Following step 2 on p. 148, choose [Select Range] and press the  button.



### 2 Choose a starting image.



- Press the  button.



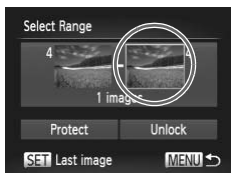



- Press the   buttons or turn the  dial to choose an image, and then press the  button.



### 3 Choose an ending image.

- Press the  button to choose [Last image], and then press the  button.



- Press the   buttons or turn the  dial to choose an image, and then press the  button.
- Images before the first image cannot be selected as the last image.



#### 4 Protect the images.

- Press the ▼ button to choose [Protect], and then press the  button.



- You can also choose the first or last image by turning the  dial when the top screen in steps 2 and 3 is displayed.



## Specifying All Images at Once

### 1 Choose [All Images].

- Following step 2 on p. 148, choose [All Images] and press the  button.



### 2 Protect the images.

- Press the ▲▼ buttons or turn the  dial to choose [Protect], and then press the  button.



- To cancel protection for groups of images, choose [Unlock] in step 4 of "Selecting a Range" or in step 2 of "Specifying All Images at Once".

## Erasing Images





You can choose and erase unneeded images one by one. Be careful when erasing images, because they cannot be recovered.

### 1 Choose an image to erase.

- Press the ◀▶ buttons or turn the  dial to choose an image.



### 2 Erase the images.

- Press the  button.
- After [Erase?] is displayed, press the ◀▶ buttons or turn the  dial to choose [Erase], and then press the  button.
- ▶ The current image is now erased.
- To cancel erasure, press the ◀▶ buttons or turn the  dial to choose [Cancel], and then press the  button.

## Erasing All Images

You can erase all images at once. Be careful when erasing images, because they cannot be recovered. However, protected images (p. 148) cannot be erased.

### Choosing a Selection Method

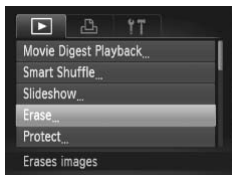

### 1 Access the setting screen.

- Press the MENU button, and then choose [Erase] on the  tab (p. 41).

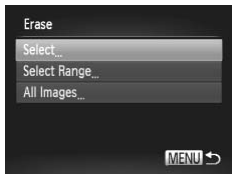

### 2 Choose a selection method.

- Choose a menu item and a setting as desired (p. 41).
- Press the ▲▼ buttons to choose a selection method, and then press the  button.
- To return to the menu screen, press the MENU button.



## Choosing Images Individually

### 1 Choose [Select].

- Following step 2 on p. 152, choose [Select] and press the  button.





### 2 Choose an image.

- Once you follow step 2 on p. 149 to choose an image, ✓ is displayed.
- To cancel erasure, press the  button again. ✓ is no longer displayed.
- Repeat this process to specify other images.



### 3 Erase the images.

- Press the **MENU** button. A confirmation message is displayed.
- Press the  buttons or turn the  dial to choose [OK], and then press the  button.

## Selecting a Range

### 1 Choose [Select Range].



- Following step 2 on p. 152, choose [Select Range] and press the  button.

### 2 Choose images.

- Follow steps 2 – 3 on p. 150 to specify images.



### 3 Erase the images.



- Press the  button to choose [Erase], and then press the  button.

### ■ Specifying All Images at Once

#### 1 Choose [All Images].

- Following step 2 on p. 152, choose [All Images] and press the  button.

#### 2 Erase the images.

- Press the ◀▶ buttons or turn the  dial to choose [OK], and then press the  button.

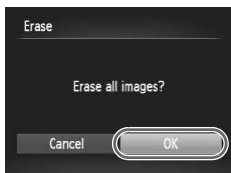

# Rotating Images

Change the orientation of images and save them as follows.

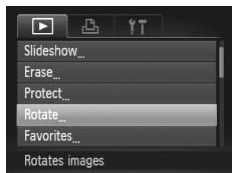





## 1 Choose [Rotate].

- Press the **MENU** button, and then choose [Rotate] on the  tab (p. 41).



## 2 Rotate the image.

- Press the   buttons or turn the  dial to choose an image.
- The image is rotated 90° each time you press the  button.
- To return to the menu screen, press the **MENU** button.



- Movies with an image quality of  or  cannot be rotated.
- Rotation is not possible when [Auto Rotate] is set to [Off] (see below).

## Deactivating Auto Rotation

Follow these steps to deactivate automatic rotation by the camera, which rotates images shot in vertical orientation so they are displayed vertically on the camera.

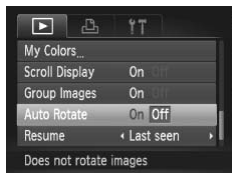

- Press the **MENU** button, choose [Auto Rotate] on the  tab, and then choose [Off] (p. 41).



- Images cannot be rotated when you set [Auto Rotate] to [Off]. Additionally, images already rotated will be displayed in the original orientation.
- In Smart Shuffle (p. 147) mode, even if [Auto Rotate] is set to [Off], images shot vertically will be displayed vertically, and rotated images will be displayed in the rotated orientation.

## Image Categories

You can tag images as favorites and assign them to My Category (p. 158). By choosing a category in filtered playback, you can restrict the following operations to all of those images.

- Viewing (p. 136), Viewing Slideshows (p. 146), Protecting Images (p. 148), Erasing Images (p. 152), Adding Images to Print Orders (DPOF) (p. 208)

### Tagging Images as Favorites

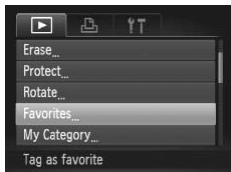

#### 1 Choose [Favorites].

- Press the **MENU** button, and then choose [Favorites] on the tab (p. 41).



#### 2 Choose an image.

- Press the buttons or turn the dial to choose an image, and then press the button. is displayed.
- To untag the image, press the button again. is no longer displayed.
- Repeat this process to choose additional images.



#### 3 Finish the setup process.

- Press the **MENU** button. A confirmation message is displayed.
- Press the buttons or turn the dial to choose [OK], and then press the .



- Images will not be tagged as favorites if you switch to Shooting mode or turn the camera off before finishing the setup process in step 3.



- Favorite images will have a three-star rating ( ) when transferred to computers running Windows 7 or Windows Vista. (Does not apply to movies or RAW images.)

## Organizing Images by Category (My Category)

You can organize images into categories. Note that images are automatically categorized at the time of shooting, according to shooting conditions.

: Images with detected faces, or images shot in or mode.

: Images detected as , , or in **AUTO** mode, or images shot in , or mode.

: Images shot in , , , , or mode.

### Choosing a Selection Method

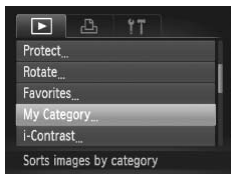

#### 1 Access the setting screen.

- Press the **MENU** button, and then choose [My Category] on the tab (p. 41).

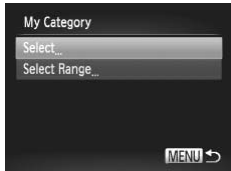

#### 2 Choose a selection method.

- Choose a menu item and a setting as desired (p. 41).
- To return to the menu screen, press the **MENU** button.

### Choosing Images Individually

#### 1 Choose [Select].

- Following step 2 above, choose [Select] and press the button.

#### 2 Choose an image.

- Press the buttons or turn the dial to choose an image.



### 3 Choose a category.

- Press the ▲▼ buttons to choose the category, and then press the **FUNC SET** button. ✓ is displayed.
- To cancel selection, press the **FUNC SET** button again. ✓ is no longer displayed.
- Repeat this process to choose additional images.



### 4 Finish the setup process.

- Press the **MENU** button. A confirmation message is displayed. Press the ◀▶ buttons or turn the **DISP** dial to choose [OK], and then press the **FUNC SET** button.

- ! Images will not be assigned to a category if you switch to Shooting mode or turn the camera off before finishing the setup process in step 4.

## Selecting a Range

### 1 Choose [Select Range].

- Following step 2 on p. 158, choose [Select Range] and press the **FUNC SET** button.

### 2 Choose images.

- Follow steps 2 – 3 on p. 150 to specify images.



### 3 Choose a category.

- Press the ▼ button to choose the type of image, and then press the ◀▶ buttons or turn the **DISP** dial to choose a category.

### 4 Finish the setup process.

- Press the ▼ button to choose [Select], and then press the **FUNC SET** button.

-  You can clear the selection of all images in the [Select Range] category by choosing [Deselect] in step 4.

# Editing Still Images

-  Image editing (pp. 160 – 164) is only available when the memory card has sufficient free space.

## Resizing Images



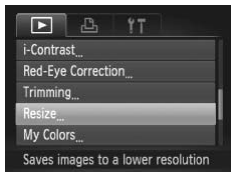

Save a copy of images at a lower resolution.







### 1 Choose [Resize].

- Press the **MENU** button, and then choose [Resize] on the  tab (p. 41).

### 2 Choose an image.





- Press the   buttons or turn the  dial to choose an image, and then press the  button.

### 3 Choose an image size.

- Press the   buttons or turn the  dial to choose the size, and then press the  button.
- ▶ [Save new image?] is displayed.







### 4 Save the new image.

- Press the   buttons or turn the  dial to choose [OK], and then press the  button.
- ▶ The image is now saved as a new file.



### 5 Review the new image.

- Press the **MENU** button. [Display new image?] is displayed.
- Press the   buttons or turn the  dial to choose [Yes], and then press the  button.
- ▶ The saved image is now displayed.





- ⓘ • Editing is not possible for images saved as **XS** in step 3.
- RAW images cannot be edited.



- Images cannot be resized to a higher resolution.

## Cropping

You can specify a portion of an image to save as a separate image file.



### 1 Choose [Trimming].

- Press the **MENU** button, and then choose [Trimming] on the tab (p. 41).

### 2 Choose an image.

- Press the buttons or turn the dial to choose an image, and then press the button.

### 3 Adjust the cropping area.

- ▶ A frame is displayed around the portion of the image to be cropped.
- ▶ The original image is shown in the upper left, and a preview of the image as cropped is shown in the lower right.
  - To resize the frame, move the zoom lever.
  - To move the frame, press the , , , buttons.
  - To change the frame orientation, press the button.
  - Faces detected in the image are shown with gray frames around them (in the upper-left image), which can be used for cropping. Switch between frames as needed by turning the dial.
  - Press the **MENU** button.



### 4 Save as a new image and review.

- Follow steps 4 – 5 on p. 160.

- ❗ • Editing is not possible for images shot at a resolution of **S** (p. 57) or resized to **XS** (p. 160).
- RAW images cannot be edited.



- Images supported for cropping will have the same aspect ratio after cropping.
- Cropped images will have a smaller resolution than uncropped images.

## Changing Image Color Tones (My Colors)

You can adjust image colors and then save the edited image as a separate file. For details on each option, see p. 102.

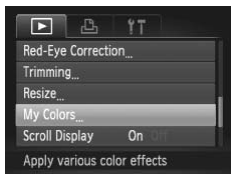

### 1 Choose [My Colors].

- Press the **MENU** button, and then choose [My Colors] on the **▶** tab (p. 41).

### 2 Choose an image.

- Press the **◀▶** buttons or turn the **DISP** dial to choose an image, and then press the **FUNC SET** button.

### 3 Choose an option.

- Press the **◀▶** buttons or turn the **DISP** dial to choose an option, and then press the **FUNC SET** button.



### 4 Save as a new image and review.

- Follow steps 4 – 5 on p. 160.

- ❗ • Image quality of pictures you repeatedly edit this way will be a little lower each time, and you may not be able to obtain the desired color.
- Colors of RAW images cannot be edited.



- The color of images edited using this function may vary slightly from the color of images shot using My Colors (p. 102).

## Correcting Image Brightness (i-Contrast)

Excessively dark image areas (such as faces or backgrounds) can be detected and automatically adjusted to the optimal brightness. Insufficient overall image contrast is also automatically corrected, to make subjects stand out better. Choose from four correction levels, and then save the image as a separate file.

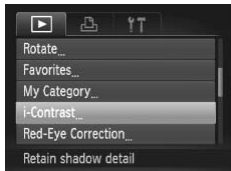

### 1 Choose [i-Contrast].

- Press the **MENU** button, and then choose [i-Contrast] on the tab (p. 41).

### 2 Choose an image.

- Press the buttons or turn the dial to choose an image, and then press the button.

### 3 Choose an option.

- Press the buttons or turn the dial to choose an option, and then press the button.



### 4 Save as a new image and review.

- Follow steps 4 – 5 on p. 160.



- For some images, correction may be inaccurate or may cause images to appear grainy.
- Images may look grainy after repeated editing using this function.
- RAW images cannot be edited this way.



- If [Auto] does not produce the expected results, try correcting images using [Low], [Medium], or [High].

## Correcting Red-Eye

Automatically corrects images affected by red-eye. You can save the corrected image as a separate file.

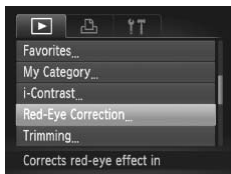

### 1 Choose [Red-Eye Correction].

- Press the MENU button, and then choose [Red-Eye Correction] on the tab (p. 41).

### 2 Choose an image.

- Press the buttons or turn the dial to choose an image.

### 3 Correct the image.

- Press the button.
- ▶ Red-eye detected by the camera is now corrected, and frames are displayed around corrected image areas.
- Enlarge or reduce images as needed. Follow the steps in “Magnifying Images” (p. 145).



### 4 Save as a new image and review.

- Press the buttons or turn the dial to choose [New File], and then press the button.
- ▶ The image is now saved as a new file.
- Follow step 5 on p. 160.



- Some images may not be corrected accurately.
- To overwrite the original image with the corrected image, choose [Overwrite] in step 4. In this case, the original image will be erased.
- Protected images cannot be overwritten.
- RAW images cannot be edited this way.
- Red-eye correction can be applied to JPEG images shot in , but the original image cannot be overwritten.

# Editing Movies

You can cut movies to remove unneeded portions at the beginning or end.

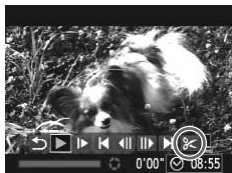

Movie Editing Panel



Movie Editing Bar

## 1 Choose ✂.

- Following steps 1 – 3 on p. 136, choose ✂ and press the **FUNC SET** button.
- ▶ The movie editing panel and editing bar are now displayed.

## 2 Specify portions to cut.



- Press the ▲▼ buttons to choose ⏪ or ⏩.
- To view the portions you can cut (identified by ✂ on the screen), press the ◀▶ buttons or turn the ⦿ dial to move ▾. Cut the beginning of the movie (from ✂) by choosing ⏪, and cut the end of the movie by choosing ⏩.
- Even if you move ▾ to a position other than a ✂ mark, choosing ⏪ will only cut the portion from the nearest ✂ to the left, and choosing ⏩ will cut the portion from the nearest ✂ to the right.

## 3 Review the edited movie.

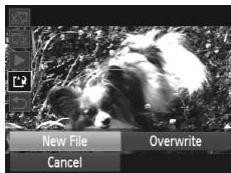
- Press the ▲▼ buttons to choose ▶, and then press the **FUNC SET** button. The edited movie is now played.
- To edit the movie again, repeat step 2.
- To cancel editing, press the ▲▼ buttons to choose ↶. Press the **FUNC SET** button, choose [OK] (either press the ◀▶ buttons or turn the ⦿ dial), and then press the **FUNC SET** button again.



### 4 Save the edited movie.

- Press the ▲▼ buttons to choose [New File], and then press the  button.
- Press the ▲▼◀▶ buttons or turn the  dial to choose [New File], and then press the  button.
- ▶ The movie is now saved as a new file.



- To overwrite the original movie with the cut one, choose [Overwrite] in step 4. In this case, the original movie will be erased.
- Only [Overwrite] is available when memory cards lack sufficient free space.
- Movies may not be saved if the battery runs out while saving is in progress.
- When editing movies, you should use a fully charged battery or an AC adapter kit (sold separately, p. 182).

# 7

## Setting Menu

Customize or adjust basic camera functions for greater convenience

## Adjusting Basic Camera Functions

Functions can be configured on the **F/T** tab. Customize commonly used functions as desired, for greater convenience (p. 41).

### Silencing Camera Operations

Silence camera sounds and movies as follows.



- Choose [Mute], and then choose [On].



- Operation can also be silenced by holding down the **▼** button as you turn the camera on.
- Sound is not played during movies if you mute camera sounds (p. 136). To restore sound during movies, press the **▲** button. Adjust volume with the **▲▼** buttons, as needed.

### Adjusting the Volume

Adjust the volume of individual camera sounds as follows.

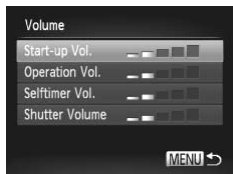



- Choose [Volume], and then press the **FUNC/SET** button.
- Choose an item, and then press the **◀▶** buttons to adjust the volume.



## Customizing Sounds

Customize camera operating sounds as follows.



- Choose [Sound Options], and then press the  button.
- Choose an item, and then press the  buttons to choose an option.

1, 2	Preset sounds (cannot be modified)
3	Preset sounds Can be changed by using the included software.



- The default shutter sound is used in  mode (p. 85), regardless of any changes to [Shutter Sound].

## Hiding Hints and Tips

Hints and tips are normally shown when you choose FUNC. menu (p. 40) or Menu (p. 41) items. If you prefer, you can deactivate this information.



- Choose [Hints & Tips], and then choose [Off].

## Screen Brightness

Adjust screen brightness as follows.

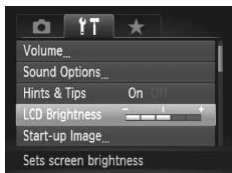

- Choose [LCD Brightness], and then press the ◀▶ buttons to adjust the brightness.





- For maximum brightness, press and hold the ▼ button for at least one second when the shooting screen is displayed or when in single-image display. (This will override the [LCD Brightness] setting on the 1/2 tab.) To restore the original brightness, press and hold the ▼ button again for at least one second or restart the camera.

## Start-up Screen

Customize the start-up screen shown after you turn the camera on as follows.



- Choose [Start-up Image], and then press the  button.
- Press the ◀▶ buttons or turn the  dial to choose an option.

	No start-up image
1, 2	Preset images (cannot be modified)
3	Preset images Assign desired shots, or use the included software to change the image.

## Customizing the Start-up Screen



### 1 Access the [Start-up Image] screen in Playback mode.

- Press the button.
- Following the previous procedure, choose [3] and press the button.



### 2 Choose one of your shots.

- Choose an image and press the button. After [Register?] is displayed, choose [OK] (either press the buttons or turn the dial), and then press the button.

- The previous start-up setting is overwritten when you assign a new start-up image.

- You can assign the operating sounds and start-up images for your camera from the included software. For details, refer to the *Software Guide*.

## Formatting Memory Cards

Before using a new memory card or a card formatted in another device, you should format the card with this camera.

Formatting erases all data on a memory card. Before formatting, copy images on the memory card to a computer, or take other steps to back them up.

An Eye-Fi card (p. 212) contains software on the card itself. Before formatting an Eye-Fi card, install the software on a computer.

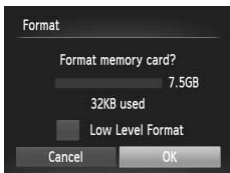

### 1 Access the [Format] screen.

- Choose [Format], and then press the button.

### 2 Choose [OK].

- Press the buttons or turn the dial to choose [OK], and then press the button.

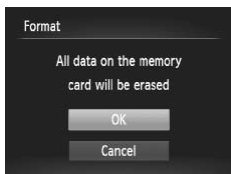

### 3 Format the memory card.

- To begin the formatting process, press the **▲▼** buttons or turn the **DISP** dial to choose [OK], and then press the **FUNC SET** button.
- When formatting is finished, [Memory card formatting complete] is displayed. Press the **FUNC SET** button.

- !** Formatting or erasing data on a memory card only changes file management information on the card and does not erase the data completely. When transferring or disposing of memory cards, take steps to protect personal information if necessary, as by physically destroying cards.

- Pencil icon** The total card capacity indicated on the formatting screen may be less than the advertised capacity.

### ■ Low-Level Formatting

Perform low-level formatting in these cases: [Memory card error] is displayed, the camera is not working correctly, card image reading/writing is slower, continuous shooting is slower, or movie recording suddenly stops. Low-level formatting erases all data on a memory card. Before low-level formatting, copy images on the memory card to a computer, or take other steps to back them up.

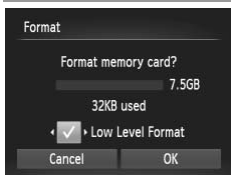

### Perform low-level formatting.

- On the screen in step 2 on p. 171, press the **▲▼** buttons or turn the **DISP** dial to choose [Low Level Format], and then select this option (mark with a **✓**) by pressing the **◀▶** buttons.
- Press the **▲▼◀▶** buttons or turn the **DISP** dial to choose [OK], press the **FUNC SET** button, and then follow step 3 on p. 171 to format (low-level format) the memory card.

- Pencil icon** Low-level formatting takes longer than “Formatting Memory Cards” (p. 171), because data is erased from all storage regions of the memory card.
- You can cancel low-level formatting in progress by choosing [Stop]. In this case, all data will be erased, but the memory card can be used normally.

## File Numbering

Your shots are automatically numbered in sequential order (0001 – 9999) and saved in folders that store up to 2,000 images each. You can change how the camera assigns file numbers.



- Choose [File Numbering], and then choose an option.

Continuous	Images are numbered consecutively (until the 9999th shot is taken/saved) even if you switch memory cards.
Auto Reset	Image numbering is reset to 0 if you switch memory cards, or when a new folder is created.



- Regardless of the option selected in this setting, shots may be numbered consecutively after the last number of existing images on newly inserted memory cards. To start saving shots from 0001, use an empty (or formatted (p. 171)) memory card.
- Refer to the *Software Guide* for information on the card folder structure and image formats.

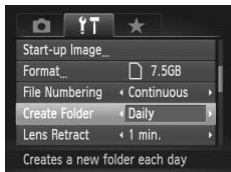

## Date-Based Image Storage

Instead of saving images in folders created each month, you can have the camera create folders each day you shoot to store shots taken that day.



- Choose [Create Folder], and then choose [Daily].
- ▶ Images will now be saved in folders created on the shooting date.

## Lens Retraction Timing

The lens is normally retracted for safety about one minute after you press the  button in Shooting mode (p. 36). To have the lens retracted immediately after you press the , set the retraction timing to [0 sec.].



- Choose [Lens Retract], and then choose [0 sec.].

## Power-Saving Adjustment



Adjust the timing of automatic camera and screen deactivation (Auto Power Down and Display Off, respectively) as needed (p. 36).



### 1 Access the [Power Saving] screen.

- Choose [Power Saving], and then press the  button.

### 2 Configure the settings.

- After choosing an item, press the   buttons to adjust it as needed.

- ⓘ • To conserve battery power, you should normally choose [On] for [Auto Power Down] and [1 min.] or less for [Display Off].



- The [Display Off] setting is applied even if you set [Auto Power Down] to [Off].







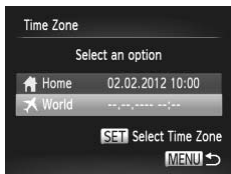



## World Clock

To ensure that your shots will have the correct local date and time when you travel abroad, simply register the destination in advance and switch to that time zone. This convenient feature eliminates the need to change the Date/Time setting manually.

Before using the world clock, be sure to set the date and time (p. 18) and your home time zone.





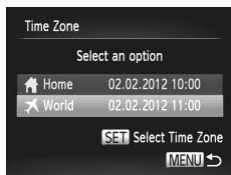

### 1 Specify your destination.

- Choose [Time Zone], and then press the  button.
- Press the  buttons or turn the  dial to choose [ World], and then press the  button.
- Press the  buttons or turn the  dial to choose the destination.
- To set daylight saving time (1 hour ahead), press the  buttons to choose .
- Press the  button.



### 2 Switch to the destination time zone.

- Press the  buttons or turn the  dial to choose [ World], and then press the **MENU** button.
- ▶  is now shown on the shooting screen (p. 222).



- Adjusting the date or time while in  mode (p. 19) will automatically update your [ Home] time and date.

### Date and Time



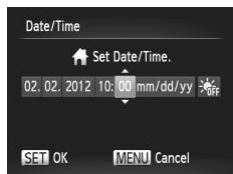

Adjust the date and time as follows.



#### 1 Access the [Date/Time] screen.

- Choose [Date/Time], and then press the  button.

#### 2 Configure the setting.

- Press the   buttons to choose an item, and then adjust the setting, either by pressing the   buttons or turning the .

### Metric/Non-Metric Display

Change the unit of measurement shown in the MF indicator (p. 106) and zoom bar (p. 44) from m/cm to ft/in as needed.



- Choose [Distance Units], and then choose [ft/in].

### Electronic Level Calibration

Calibrate the electronic level if it seems ineffective in helping you level the camera.

For greater calibration accuracy, display grid lines (p. 128) to help you level the camera in advance.

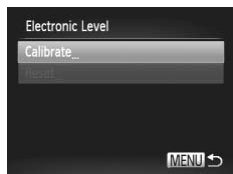

#### 1 Level the camera.



- Mount the camera on a tripod and make sure it is level.



## 2 Access the [Electronic Level] screen.

- Choose [Electronic Level], and then press the  button.



## 3 Calibrate the electronic level.

- Choose [Calibrate] and press the  button. A confirmation message is displayed.
- Choose [OK], and then press the  button.

### Resetting the Electronic Level

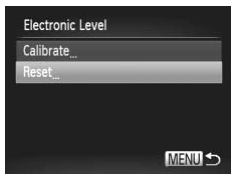
Restore the electronic level to its original state as follows. Note that this is not possible unless you have calibrated the electronic level.







- Choose [Electronic Level], and then press the  button.
- Choose [Reset], and then press the  button.
- ▶ Once the electronic level has been reset, the menu screen is displayed again.

## Setting Copyright Information to Record in Images

To record the author's name and copyright details in images, set this information beforehand as follows.



### 1 Access the setting screen.

- Choose [Copyright Info], and then press the  button.
- Press the  buttons or turn the  dial to choose [Enter Author's Name] or [Enter Copyright Details], and then press the  button.

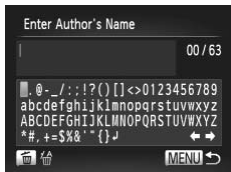

### 2 Enter a name.

- Press the ▲▼◀▶ buttons or turn the dial to choose a character, and then press the button to enter it.
- Up to 63 characters can be used.
- Press the button to delete single characters.
- Turn the dial or choose ◀ or ▶ and press the button to move the cursor.

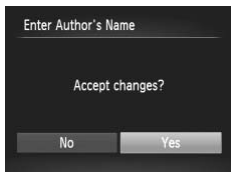

### 3 Save the settings.

- Press the **MENU** button. [Accept changes?] is displayed.
- Press the ◀▶ buttons or turn the dial to choose [Yes], and then press the button.
- ▶ The information set here will now be recorded in images.



- To check the information entered, choose [Display Copyright Info] on the screen in step 1, and then press the button.
- You can also use the included software (p. 26) to enter, change, and delete copyright information. Some characters entered with the included software may not display on the camera, but will be correctly recorded in images.
- You can view, change, and delete copyright information recorded in images by using the included software after saving images to a computer.

## ■ Deleting All Copyright Information

You can delete both the author's name and copyright details at the same time as follows.

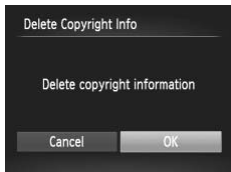

- Follow step 1 on p. 177 and choose [Delete Copyright Info].
- Press the ◀▶ buttons or turn the dial to choose [OK], and then press the button.



- The copyright info already recorded in images will not be deleted.

## Display Language







Change the display language as needed.

English	Svenska	Türkçe
Deutsch	Español	繁體中文
Français	简体中文	한국어
Nederlands	Русский	മലിന
Dansk	Português	العربية
Suomi	Ελληνικά	Română
Italiano	Polski	فارسی
Norsk	Čeština	हिन्दी
Українська	Magyar	日本語

### 1 Access the [Language] screen.

- Choose [Language] , and then press the  button.

### 2 Configure the setting.

- Press the     buttons or turn the  dial to choose a language, and then press the  button.



- You can also access the [Language] screen in Playback mode by pressing and holding the  button and immediately pressing the MENU button.

## Adjusting Other Settings

The following settings can also be adjusted on the  tab.

- [Video System] (p. 187)
- [Ctrl via HDMI] (p. 188)
- [Eye-Fi Settings] (p. 212)

## Restoring Defaults



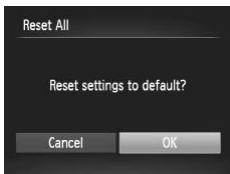

If you accidentally change a setting, you can restore default camera settings.





### 1 Access the [Reset All] screen.

- Choose [Reset All], and then press the  button.

### 2 Restore default settings.

- Press the   buttons or turn the  dial to choose [OK], and then press the  button.
- ▶ Default settings are now restored.



- The following functions are not restored to default settings.
  -  tab settings [Time Zone] (p. 175), [Date/Time] (p. 176), [Language] (p. 179), [Video System] (p. 186), and the image assigned to [Start-up Image] (p. 170)
  - Custom white balance data you have recorded (p. 101)
  - Colors chosen in Color Accent (p. 78) or Color Swap (p. 79)
  - Shooting mode chosen in **SCN** (p. 68) or  (p. 71) mode
  - Exposure compensation (p. 93) setting
  - The movie mode (p. 88)
  - Calibrated value for the electronic level (p. 176)
  - Copyright information (p. 177)

# 8

## Accessories

Use included accessories effectively and enjoy the camera in more ways with optional Canon accessories and other compatible accessories sold separately

## Tips on Using Included Accessories

### Effective Battery and Charger Use

- **Charge the battery on (or immediately before) the day of use**

Charged batteries gradually lose their charge, even when they are not used.

You can easily check the charge state of the battery by attaching the cover so that ▲ is visible on a charged battery, and attaching it so that ▲ is not visible on an uncharged battery.



- **Long-term battery storage**

After using up all remaining battery power, remove the battery from the camera. Store the battery with the cover attached. Storing a partially charged battery over extended periods (about a year) may shorten its life or affect performance.

- **Using the battery charger abroad**

The charger can be used in areas with 100 – 240 V AC power (50/60 Hz). For power outlets in a different format, use a commercially available adapter for the plug. Never use an electrical transformer designed for traveling, which may damage the battery.

## Optional Accessories

The following camera accessories are sold separately. Note that availability varies by area, and some accessories may no longer be available.

### Power Supplies

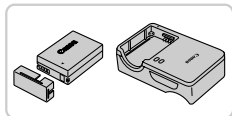

#### Battery Pack NB-10L

- Rechargeable lithium-ion battery

#### Battery Charger CB-2LC

- Charger for Battery Pack NB-10L

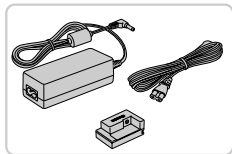

#### AC Adapter Kit ACK-DC80

- For powering the camera using household power. Recommended when using the camera over extended periods, or when connecting the camera to a printer or computer. Cannot be used to charge the camera battery.

- ❗ • The battery charger and AC adapter kit can be used in areas with 100 – 240 V AC power (50/60 Hz).
- For power outlets in a different format, use a commercially available adapter for the plug. Never use an electrical transformer designed for traveling, which may damage the battery.

## Flash Units



### Speedlite 580EX II/430EX II/320EX/270EX II

- Shoe-mounted flash unit that enables many styles of flash photography.

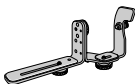

### Speedlite Bracket SB-E2

- Prevents unnatural shadows next to subjects during vertical shooting. Includes Off-Camera Shoe Cord OC-E3.



### Speedlite Transmitter ST-E2

- Enables wireless control of slave Speedlite flash units.

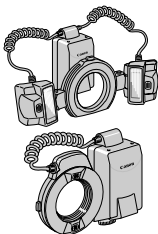

### Macro Twin Lite MT-24EX

### Macro Ring Lite MR-14EX

- External macro flash units that enable many styles of macro flash photography. The Macro Twin Lite requires Macrolite Adapter MLA-DC1, Off-Camera Shoe Cord OC-E3, and Bracket BKT-DC1 (all sold separately) for attachment to the camera. The Macro Ring Lite requires Macrolite Adapter MLA-DC1 (sold separately) for attachment to the camera.

## Optional Accessories



### Off-Camera Shoe Cord OC-E3

- Used to attach a Macro Twin Lite flash to the camera.

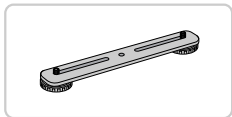

### Bracket BKT-DC1

- Used to attach a Macro Twin Lite flash to the camera.

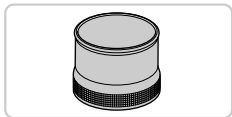

### Macrolite Adapter MLA-DC1

- Used to attach a Macro Ring Lite or Macro Twin Lite flash to the camera.

## Other Accessories



### Soft Case SC-DC75

- Protects the camera from dust and scratches. Handle with care to prevent leather discoloration.



### Waterproof Case WP-DC44

- For underwater photography at depths of up to 40 meters (130 ft.). Also useful for shooting in the rain, at the beach, or on ski slopes.

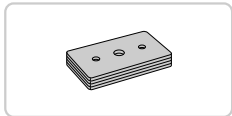

### Waterproof Case Weight WW-DC1

- Prevents the waterproof case from floating during underwater photography.

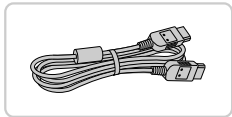

### HDMI Cable HTC-100

- For connecting the camera to an HDMI input of a high-definition TV.



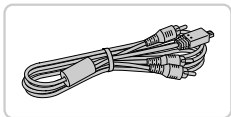

### Stereo AV Cable AVC-DC400ST

- Connect the camera to a TV to enjoy playback on the larger TV screen.

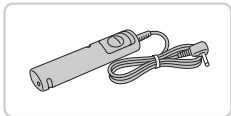

### Remote Switch RS60-E3

- Enables remote shutter button operation (pressing the button halfway or all the way down).



### Lens Hood LH-DC70

- Prevents extraneous light outside the angle of view from entering the lens and causing flares or ghosting, which reduce image quality.



### Filter Adapter FA-DC58C

- Adapter required when mounting a 58 mm filter.

### Canon Lens Filter (58 mm dia.)

- Protects the lens and enables a variety of shooting effects.



- A lens hood and filter adapter cannot be attached to the camera at the same time.

## Printers



SELPHY  
Series



PIXMA  
Series

### Canon PictBridge-Compatible Printers

- Printing images without a computer is possible by connecting the camera to a Canon PictBridge-compatible printer. For details, visit your nearest Canon dealer.

## Playback on a TV

By connecting the camera to a TV, you can view your shots on the larger screen of the TV.

For details on connection or how to switch inputs, refer to the TV manual.



- Some information may not be displayed when viewing images on a TV (p. 224).

## Playback on a Standard-Definition TV

Connecting the camera to a TV with the Stereo AV Cable AVC-DC400ST (sold separately) enables you to view your shots on the larger screen of the TV as you control the camera.

### 1 Make sure the camera and TV are off.

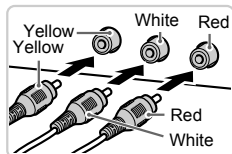

### 2 Connect the camera to the TV.

- On the TV, insert the cable plugs fully into the video inputs as shown.
- On the camera, open the terminal cover and insert the cable plug fully into the camera terminal.

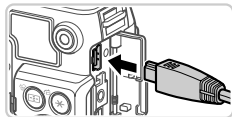

### 3 Turn the TV on and switch to video input.

- Switch the TV input to the video input you connected the cable to in step 2.

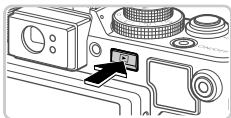

#### 4 Turn the camera on.

- Press the  button to turn the camera on.
- ▶ Images from the camera are now displayed on the TV. (Nothing is displayed on the camera screen.)
- When finished, turn off the camera and TV before disconnecting the cable.



- Correct display is not possible unless the camera video output format (NTSC or PAL) matches the TV format. To change the video output format, press the **MENU** button and choose [Video System] on the  tab.



- When the camera and TV are connected, you can also shoot while previewing shots on the larger screen of the TV. To shoot, follow the same steps as when using the camera screen.

### ■ Playback on a High-Definition TV

Connecting the camera to an HDTV with the HDMI Cable HTC-100 (sold separately) enables you to view your shots on the larger screen of the TV. Movies shot at a resolution of  $\overline{1920}$  or  $\overline{1280}$  can be viewed in high-definition.

#### 1 Make sure the camera and TV are off.

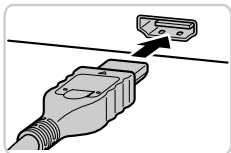

#### 2 Connect the camera to the TV.

- On the TV, insert the cable plug fully into the HDMI input as shown.
- On the camera, open the terminal cover and insert the cable plug fully into the camera terminal.

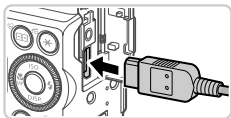

### 3 Display images.

- Follow steps 3 – 4 on p. 186 to display images.



- Camera operating sounds are not played while the camera is connected to an HDTV.

## ■ Controlling the Camera with a TV Remote

Connecting the camera to an HDMI CEC-compatible TV enables playback (including slideshow playback) using the TV remote control.

In this case, you will need to adjust some TV settings. For details, refer to the TV user manual.

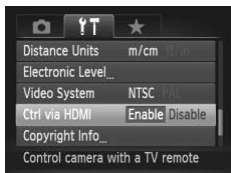

### 1 Configure the settings.

- Press the **MENU** button, choose [Ctrl via HDMI] on the **YT** tab, and then choose [Enable] (p. 41).

### 2 Connect the camera to the TV.

- Follow steps 1 – 2 on p. 187 to connect the camera to the TV.









### 3 Display images.

- Turn on the TV. On the camera, press the **▶** button.
- ▶ Images from the camera are now displayed on the TV. (Nothing is displayed on the camera screen.)

### 4 Control the camera with the TV remote.

- Press the **◀▶** buttons on the remote to browse images.
- To display the camera control panel, press the **OK/Select** button. Select control panel items by pressing the **◀▶** buttons to choose an item, and then pressing the **OK/Select** button again.

## Camera Control Panel Options Shown on the TV

 Return	Closes the menu.
 Group Playback	Displays sets of images shot in  mode (p. 85). (Only displayed when a grouped image is selected.)
 Play Movie	Starts movie playback. (Only displayed when a movie is selected.)
 Slideshow	Starts slideshow playback. To switch images during playback, press the   buttons on the remote control.
 Index Playback	Displays multiple images in an index.
DISP. Change Display	Switches display modes (p. 39).



- Pressing any buttons on the camera will switch control to the camera itself, which will prevent remote control until you return to single-image display.
- The camera may not always respond correctly even if the remote is for an HDMI CEC-compatible TV.

## Powering the Camera with Household Power

Powering the camera with AC Adapter Kit ACK-DC80 (sold separately) eliminates the need to monitor the remaining battery level.

**1 Make sure the camera is off.**

**2 Connect the adapter to the coupler.**

- Insert the adapter plug fully into the coupler.

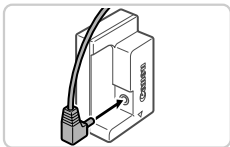

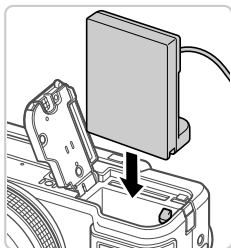

### 3 Insert the coupler.

- Follow step 2 on p. 15 to open the cover, and then insert the coupler as shown until it locks into place.

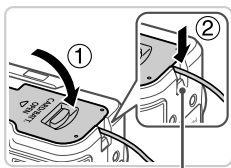

- Close the cover (①) making sure the coupler cable fits into the coupler cable port (②) and press downward until it clicks into place.

Coupler Cable Port

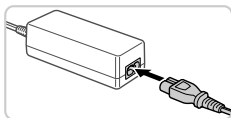

### 4 Connect the power cord.

- Insert one end of the power cord into the compact power adapter, and then plug the other end into a power outlet.
- Turn the camera on and use it as desired.
- When finished, turn the camera off and unplug the power cord from the outlet.



- Do not disconnect the adapter or unplug the power cord while the camera is still on. This may erase your shots or damage the camera.
- Do not attach the adapter or adapter cord to other objects. Doing so could result in malfunction or damage to the product.

## Using a Lens Hood (Sold Separately)

For wide-angle shots of backlit subjects without using the flash, attach optional Lens Hood LH-DC70 to prevent light outside the angle of view from entering the lens.

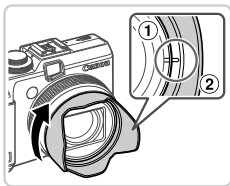

### Attach the hood.

- Align the lens hood mark (2) with the camera mark (1), and turn the lens hood in the direction of the arrow until it locks in place.
- To remove the lens hood, turn it the opposite direction.

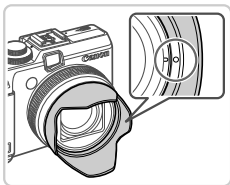

! • Vignetting may occur if you use the built-in flash when the lens hood is attached.

 • The filter adapter and a lens hood cannot be attached to the camera at the same time.

## Using Lens Filters (Sold Separately)

Attaching a lens filter to the camera protects the lens and allows you to shoot with various effects. To attach a lens filter, you will need Filter Adapter FA-DC58C (sold separately).

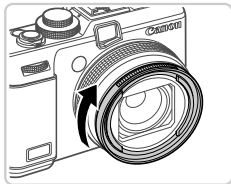

### 1 Attach the filter adapter.

- Align the notches on the camera and the filter adapter and turn the adapter in the direction of the arrow until locked.
- To remove the filter adapter, turn it in the opposite direction.

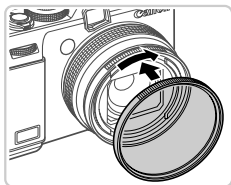

### 2 Attach a filter.

- Turn the filter in the direction of the arrow to attach it to the camera.
- Make sure not to attach the filter too tightly. Doing so could prevent removal of the filter and damage the camera.



- We recommend the use of genuine Canon filters (58 mm dia.).
- When not using auto focus to shoot, set the manual focus option [Safety MF] to [On].
- If you use the built-in flash with the filter adapter attached, portions of the image may appear darker.
- When using the filter adapter, be sure to use only one filter at a time. Attaching multiple filters, or accessories such as a heavy lens, may cause the attachments to fall off or damage the camera or adapter.
- Do not grip the filter adapter tightly.
- Remove the filter adapter when not using a filter.



- The filter adapter and a lens hood cannot be attached to the camera at the same time.



## Using a Remote Switch (Sold Separately)

An optional Remote Switch RS60-E3 can be used to avoid camera shake that may otherwise occur when pressing the shutter button directly. This optional accessory is convenient when shooting at slow shutter speeds.

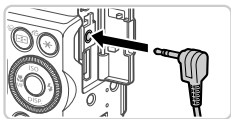

### 1 Connect the remote switch.

- Make sure the camera is off.
- Open the terminal cover and insert the remote switch plug.



### 2 Shoot.

- To shoot, press the release button on the remote switch.



- Bulb photography (long exposures) is not supported.

## Using an External Flash (Sold Separately)

More sophisticated flash photography is possible with an optional Speedlite EX series flash. For movie shooting using an LED light, the optional Speedlite 320EX flash is available.



- This camera does not support some Speedlite EX series functions.
- Non-EX series Canon flash units may not fire correctly or may not fire at all, in some cases.
- Use of non-Canon flash units (especially high-voltage flash units) or flash accessories may prevent normal camera operation and may damage the camera.



- Also refer to the Speedlite EX series manual for additional information.

## Speedlite 580EX II/430EX II/320EX/270EX II

These optional flash units can provide bright lighting and meet a variety of flash photography needs.

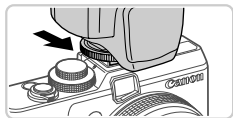

- 1 **Attach the flash unit to the hot shoe.**
- 2 **Turn the flash on, and then turn the camera on.**

- ▶ A red  icon is now displayed.
- ▶ The flash pilot lamp will light up when the flash is ready.





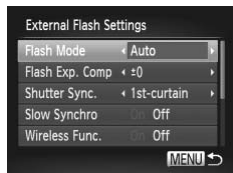

- 3 **Choose shooting mode **P**, **Tv**, **Av**, or **M**.**

- Flash settings can only be configured in these modes. In other modes, the flash is adjusted and fired automatically, as needed.

- 4 **Set the white balance to  (p. 100).**



- 5 **Configure settings for the external flash.**

- Press the **MENU** button, choose [Flash Control] on the  tab, and then press the  button.
- ▶ Options already set on the flash itself are displayed.
- Press the   buttons or turn the  dial to choose an item, and then adjust the setting by pressing the   buttons.
- Available settings vary depending on the shooting mode and the flash attached (p. 200).



- Settings for the built-in flash cannot be configured while a Speedlite EX series flash is attached, because that setting screen is no longer accessible.
- You can also access the setting screen by pressing the **▶** button for at least one second.
- Flash settings in **AF** shooting mode can be configured just as they are in **P** mode.
- 580EX II only: [Flash Control] is not available if the external flash has been set up for stroboscopic flash.
- 320EX only: Auto LED lighting is only available in low-light movie recording or in Movie mode. In this case, the  icon is shown.

Still Images

Movies

## Using Speedlite Bracket SB-E2 (Sold Separately)

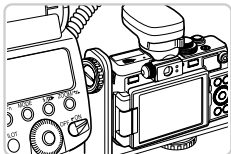

- Using the optional Speedlite Bracket SB-E2 can help prevent unnatural shadows next to subjects during vertical shooting.
- To keep the LCD screen out of the way of the bracket, use the screen closed and facing outward.



Still Images

## Macro Ring Lite MR-14EX

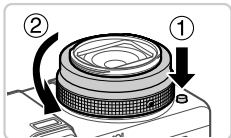
This optional flash unit enables many styles of macro flash photography. Requires Macrolite Adapter MLA-DC1 (sold separately) for attachment to the camera.



### 1 Remove the ring.

- Make sure the camera is off.
- Hold down the ring release button (1) and turn the ring in the direction of the arrow (2).
- Align the  mark on the ring with the  mark on the camera, and then lift the ring off.

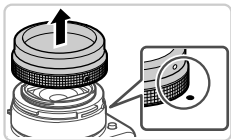

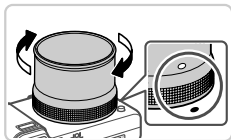

**2 Attach the macrolite adapter.**

- Align the ● mark on the macrolite adapter with the ● mark on the camera, and then turn the adapter in the direction of the arrows until it locks in place.
- To remove the adapter, hold down the ring release button and turn the adapter in the opposite direction.

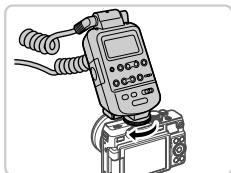

**3 Attach the controller to the camera.**

- Attach the control component of the macro ring lite to the hot shoe on top of the camera.

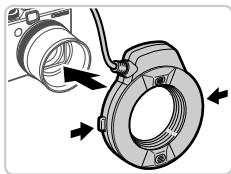

**4 Attach the flash unit to the macrolite adapter.**

- Press the release buttons on both sides of the macro ring lite and attach the macro ring lite to the macrolite adapter.

**5 Choose shooting mode **P**, **Tv**, **Av**, or **M**.**

- Flash settings can only be configured in these modes. In other modes, the flash is adjusted and fired automatically, as needed.

**6 Set the white balance to  $\zeta$  (p. 100).**

**7 Enter  $\text{🌸}$  mode (p. 105).**

**8 Set [ND Filter] to [On] (p. 99).****9 Configure the external flash.**

- Follow step 5 on p. 194 to adjust the settings.



- Keep cords (from the macro ring lite) away from flash heads.
- When using a tripod, adjust the position of the legs to prevent them from coming into contact with the flash heads.
- Use the screen to compose shots, because the viewfinder cannot be used with these accessories attached.

**Macro Twin Lite MT-24EX**

This optional flash unit enables many styles of macro flash photography. Requires Macrolite Adapter MLA-DC1, Off-Camera Shoe Cord OC-E3, and Bracket BKT-DC1 (all sold separately) for attachment to the camera.

**1 Remove the ring and attach the macrolite adapter.**

- Follow steps 1 – 2 on p. 195 to remove the ring, and then attach the macrolite adapter.

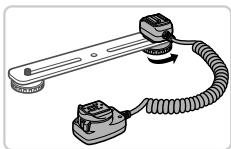
**2 Attach the off-camera shoe cord to the bracket.**

- Slide the bracket screw to the outer end of the bracket. Align the bracket screw with the tripod socket of the off-camera shoe cord, and then tighten the screw to secure it.

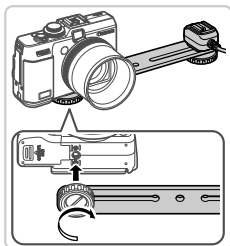

**3 Attach the bracket to the camera.**

- Slide the other bracket screw to the outer end of the bracket. Align the bracket screw with the tripod socket on the bottom of the camera, and then tighten the screw to secure it.

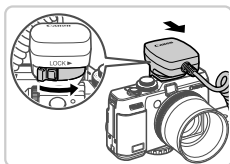

**4 Attach the off-camera shoe cord to the camera.**

- Attach the camera connection component of the off-camera shoe cord to the hot shoe on top of the camera.

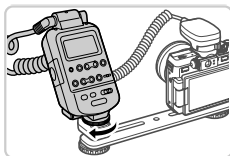

**5 Attach the controller to the off-camera shoe cord.**

- Attach the controller for the Macro Twin Lite to the flash connection component of the off-camera shoe cord.

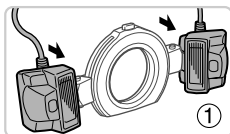

**6 Attach the flash unit to the macrolite adapter.**

- Attach each flash head to the respective mount (①). Press the release button on the top of the ring in and attach the ring to the macrolite adapter (②).

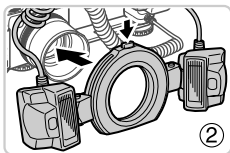

## 7 Configure the external flash and settings on the camera.

- Follow steps 5 – 9 on p. 196 to configure the settings.



- Keep cords (from the macro twin lite and off-camera shoe cord) away from flash heads.
- When using a tripod, adjust the position of the legs to prevent them from coming into contact with the flash heads or the bracket.
- Depending on the position where you have attached the flash controller, it may come into contact with the LCD monitor. To prevent this, adjust the position of attachment or the orientation of the controller, adjust the angle of the screen, or use the screen closed and facing outward.
- Use the screen to compose shots, because the viewfinder cannot be used with these accessories attached.

## ■ Camera Settings Available with an External Flash (Sold Separately)

The following settings are available in **P**, **Tv**, **Av**, or **M** mode. In other shooting modes, only [Red-Eye Corr.] and [Red-Eye Lamp] can be configured. (The flash is adjusted and fired automatically, as needed.)

Item	Options	Shooting Mode			
		P	Tv	Av	M
Flash Mode	Auto*1	○	○	○	—
	Manual*2	○	○	○	○
Flash Exp. Comp*3	-3 to +3	○	○	○	—
Flash Output*4	1/128*5 to 1/1 (in 1/3-stop increments)	○	○	○	○
Shutter Sync.	1st-curtain/2nd-curtain/Hi-speed	○	○	○	○
Slow Synchro	On	○	○	○	○
	Off	○	—	○	—
Wireless Func.*6	On/Off	○	○	○	○
Red-Eye Corr.	On/Off	○	○	○	○
Red-Eye Lamp	On/Off	○	○	○	○
Safety FE*7	On	○	○	○	—
	Off	○	○	○	○
Clear Flash Settings*8		○	○	○	○

\*1 E-TTL mode is used for the flash.

\*2 M mode is used for the flash.

In **M** shooting mode, E-TTL mode is also available for the flash. In this case, when the flash fires, flash exposure compensation set on the flash is applied to the flash output level set on the camera.

\*3 Can be configured only when [Flash Mode] is [Auto] and flash exposure compensation set on the flash is [+0]. When you adjust flash exposure compensation on the flash, the camera display will be updated (580EX II and 430EX II only).

\*4 Can be configured when [Flash Mode] is [Manual]. Linked to settings on the flash unit.

\*5 1/64 for Speedlite 430EX II/320EX/270EX II, Macro Ring Lite MR-14EX, and Macro Twin Lite MT-24EX.



- \*6 For options other than On/Off, configure the setting on the flash unit itself. Not available with Speedlite 430EX II/320EX/270EX II, Macro Ring Lite MR-14EX, or Macro Twin Lite MT-24EX. When this setting is set to [On], [Shutter Sync.] cannot be set to [2nd-curtain]. (If [Shutter Sync.] is set to [2nd-curtain], it will be changed to [1st-curtain].)
- \*7 Can only be configured when [Flash Mode] is [Auto].
- \*8 Restores all default settings. You can also restore defaults for [Slow Synchro], [Safety FE], [Red-Eye Corr.], and [Red-Eye Lamp] by using [Reset All] in the  menu on the camera (p. 179).



- Flash settings in  shooting mode can be configured just as they are in **P** mode.

## Printing Images

Your shots can easily be printed by connecting the camera to a printer. On the camera, you can specify images to set up batch printing, prepare orders for photo development services, and prepare or print images for photobooks. A Canon SELPHY CP series compact photo printer is used here for the sake of illustration. Screens displayed and available functions vary by printer. Also refer to the printer manual for additional information.

### Easy Print

Easily print your shots by connecting the camera to a PictBridge-compatible printer (sold separately) with the included interface cable (p. 2).

#### 1 Make sure the camera and printer are off.

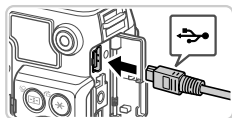

#### 2 Connect the camera to the printer.

- Open the cover. Holding the smaller cable plug in the orientation shown, insert the plug fully into the camera terminal.
- Connect the larger cable plug to the printer. For other connection details, refer to the printer manual.

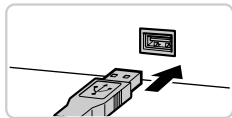

#### 3 Turn the printer on.

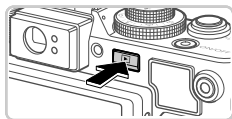

#### 4 Turn the camera on.

- Press the  button to turn the camera on.



- ▶ is displayed.

## 5 Choose an image.

- Press the ◀▶ buttons or turn the dial to choose an image.

## 6 Print the image.

- Press the button.
- ▶ Printing now begins.
- To print other images, repeat steps 5 – 6 after printing is finished.
- When you are finished printing, turn the camera and printer off and disconnect the interface cable.



- For Canon PictBridge-compatible printers (sold separately), see p. 185.
- RAW images cannot be printed.

## Configuring Print Settings

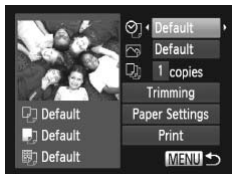



### 1 Access the printing screen.

- After following steps 1 – 5 on p. 202 to choose an image, press the button to access the screen at left.

### 2 Configure the setting.

- Press the ▲▼ buttons or turn the dial to choose an item, and then choose an option by pressing the ◀▶ buttons.

	Default	Matches current printer settings.
	Date	Prints images with the date added.
	File No.	Prints images with the file number added.
	Both	Prints images with both the date and file number added.
	Off	—
	Default	Matches current printer settings.
	Off	—
	On	Uses information from the time of shooting to print under optimal settings.
	Red-Eye 1	Corrects red-eye.
	No. of Copies	Choose the number of copies to print.
<b>Trimming</b>	—	Specify a desired image area to print (see below).
<b>Paper Settings</b>	—	Specify the paper size, layout, and other details (p. 205).

### ■ Cropping Images Before Printing (Trimming)



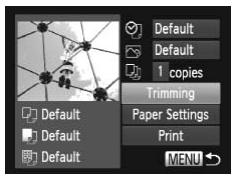



By cropping images before printing, you can print a desired image area instead of the entire image.





#### 1 Choose [Trimming].

- After following step 1 on p. 203 to access the printing screen, choose [Trimming] and press the  button.
- ▶ A cropping frame is now displayed, indicating the image area to print.

#### 2 Adjust the cropping frame as needed.

- To resize the frame, move the zoom lever.
- To move the frame, press the     buttons.
- To rotate the frame, turn the .
- When finished, press the .

### 3 Print the image.

- On the screen in step 1, press the ▲▼ buttons or turn the  dial to choose [Print], and then press the  button.



- Cropping may not be possible at small image sizes, or at some aspect ratios.
- Dates may not be printed correctly if you crop images shot with [Date Stamp] selected.

## Choosing Paper Size and Layout Before Printing



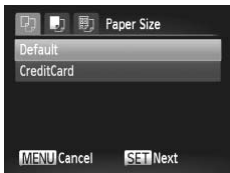

### 1 Choose [Paper Settings].

- After following step 1 on p. 203 to access the printing screen, choose [Paper Settings] and press the  button.



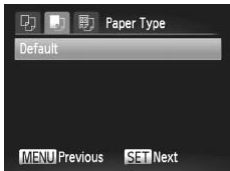

### 2 Choose a paper size.

- Press the ▲▼ buttons or turn the  dial to choose an option, and then press the  button.





### 3 Choose a type of paper.

- Press the ▲▼ buttons or turn the  dial to choose an option, and then press the  button.



### 4 Choose a layout.

- Press the ▲▼ buttons or turn the  dial to choose an option.
- When choosing [N-up], press the ◀▶ buttons to specify the number of images per sheet.
- Press the  button.

### 5 Print the image.

## Available Layout Options



Default	Matches current printer settings.
Bordered	Prints with blank space around the image.
Borderless	Borderless, edge-to-edge printing.
N-up	Choose how many images to print per sheet.
ID Photo	Prints images for identification purposes. Only available for images with a resolution of L and an aspect ratio of 4:3.
Fixed Size	Choose the print size. Choose from 3.5 x 5 in., postcard, or wide-format prints.

## Printing ID Photos

### 1 Choose [ID Photo].

- Following steps 1 – 4 on p. 205, choose [ID Photo] and press the  button.

### 2 Choose the long and short side length.

- Press the ▲▼ buttons or turn the  dial to choose an item. Choose the length by pressing the ◀▶ buttons, and then press the  button.

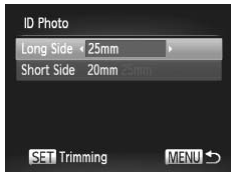



### 3 Choose the printing area.

- Follow step 2 on p. 204 to choose the printing area.

### 4 Print the image.

## Printing Movie Scenes

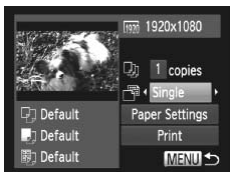

### 1 Access the printing screen.

- Follow steps 1 – 5 on p. 202 to choose a movie, and then press the button.
- Press the buttons to choose , and then press the button. The screen at left is displayed.

### 2 Choose a printing method.

- Press the buttons or turn the dial to choose , and then press the buttons to choose the printing method.

### 3 Print the image.

## Movie Printing Options

Single	Prints the current scene as a still image.
Sequence	Prints a series of scenes, a certain interval apart, on a single sheet of paper. You can also print the folder number, file number, and elapsed time for the frame by setting [Caption] to [On].



- To cancel printing in progress, press the button.
- [ID Photo] and [Sequence] are not available with Canon PictBridge-compatible printer models earlier than CP720 and CP730.

## Adding Images to Print Orders (DPOF)

Batch printing (p. 211) and ordering prints from a photo development service can be set up on the camera. Choose up to 998 images on a memory card and configure relevant settings, such as the number of copies, as follows. The printing information you prepare this way will conform DPOF (Digital Print Order Format) standards.





- RAW images cannot be included in print orders.











### Adding Images to Print Orders via the Button

You can add images to print orders (DPOF) after your shot or later during playback simply by pressing the  button.

#### 1 Choose an image.

- Press the   buttons or turn the  dial to choose an image.

#### 2 Add the image to the print list.

- Press the  button.
- Press the   buttons to specify the number of prints. Choose [Add] by pressing the   buttons or turning the  dial, and then press the  button.
- To remove the image from the print order, repeat steps 1 – 2 but choose [Remove] by pressing the   buttons or turning the  dial, and then press the  button.

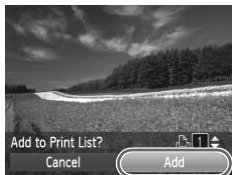



- Print orders cannot be set up while the camera is connected to a printer.

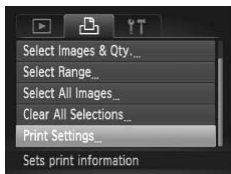

## Configuring Print Settings

Specify the printing format, whether to add the date or file number, and other settings as follows. These settings apply to all images in the print order.



- Press the **MENU** button, and then choose [Print Settings] on the  tab. Choose and configure settings as desired (p. 41).

<b>Print Type</b>	Standard	One image is printed per sheet.
	Index	Smaller versions of multiple images are printed per sheet.
	Both	Both standard and index formats are printed.
<b>Date</b>	On	Images are printed with the shooting date.
	Off	—
<b>File No.</b>	On	Images are printed with the file number.
	Off	—
<b>Clear DPOF data</b>	On	All image print order settings are cleared after printing.
	Off	—

- ⓘ Not all of your DPOF settings may be applied in printing by the printer or photo development service, in some cases.
- ⓘ may be displayed on the camera to warn you that the memory card has print settings that were configured on another camera. Changing the print settings using this camera may overwrite all previous settings.
- Setting [Date] to [On] may cause some printers to print the date twice.



- Specifying [Index] will prevent you from choosing [On] for both [Date] and [File No.] at the same time.
- The date is printed in a format matching setting details in [Date/Time] on the  tab, accessible by pressing the **MENU** button (p. 18).
- Index printing is not available on some Canon PictBridge-compatible printers (sold separately).

## Setting Up Printing for Individual Images

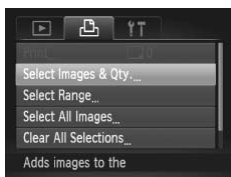

### 1 Choose [Select Images & Qty.].

- Press the **MENU** button, choose [Select Images & Qty.] on the tab, and then press the button.

### 2 Choose an image.

- Press the buttons or turn the dial to choose an image, and then press the button.
- ▶ You can now specify the number of copies.
- If you specify index printing for the image, it is labeled with a icon. To cancel index printing for the image, press the button again. is no longer displayed.



### 3 Specify the number of prints.

- Press the buttons or turn the dial to specify the number of prints (up to 99).
- To set up printing for other images and specify the number of prints, repeat steps 2 – 3.
- Printing quantity cannot be specified for index prints. You can only choose which images to print, by following step 2.
- When finished, press the **MENU** button to return to the menu screen.

## Setting Up Printing for a Range of Images

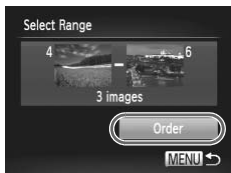

### 1 Choose [Select Range].

- Following step 1 above, choose [Select Range] and press the button.

### 2 Choose images.

- Follow steps 2 – 3 on p. 150 to specify images.

### 3 Configure the print settings.

- Press the ▲▼ buttons to choose [Order], and then press the  button.

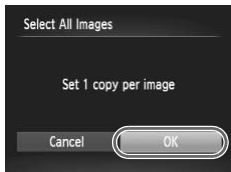

## Setting Up Printing for All Images



### 1 Choose [Select All Images].

- Following step 1 on p. 210, choose [Select All Images] and press the  button.

### 2 Configure the print settings.

- Press the ◀▶ buttons or turn the  dial to choose [OK], and then press the  button.

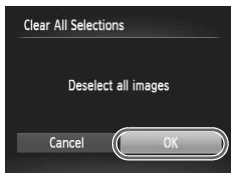

## Clearing All Print Orders



### 1 Choose [Clear All Selections].

- Following step 1 on p. 210, choose [Clear All Selections] and press the  button.

### 2 Confirm clearing the order.

- Press the ◀▶ buttons or turn the  dial to choose [OK], and then press the  button.

## Printing Images Added to Print Orders (DPOF)



- When images have been added to the print list (pp. 208 – 211), the screen at left is displayed after you connect the camera to a PictBridge-compatible printer. Press the ▲▼ buttons to choose [Print now], and then simply press the  button to print the images in the print list.
- Any DPOF print job that you temporarily stop will be resumed from the next image.

## Using an Eye-Fi Card

Before using an Eye-Fi card, always confirm that local use is permitted (p. 3).







Inserting a prepared Eye-Fi card enables automatic wireless transfer of images to a computer or uploading to a photo-sharing website.

Images are transferred by the Eye-Fi card. Refer to the card's user manual or contact the manufacturer for instructions on preparing and using cards or resolving transfer problems.





- When using an Eye-Fi card, keep the following points in mind.
  - Cards may continue to transmit radio waves even when [Eye-Fi trans.] is set to [Disable] (p. 213). Remove the Eye-Fi card before entering hospitals, aircraft, or other areas where transmission is prohibited.
  - When troubleshooting image transfer issues, check the card and computer settings. For details, refer to the card's user manual.
  - Poor wireless connections may cause image transfer to take a long time, and transfer may be interrupted in some cases.
  - Eye-Fi cards may become hot, due to their transfer functions.
  - Battery power will be consumed faster than in normal use.
  - Camera operation may become sluggish. To resolve this, try setting [Eye-Fi trans.] to [Disable].

Connection status of Eye-Fi cards in the camera can be checked on the shooting screen (in regular information display mode) or playback screen (in simple information display mode).

 (Gray)	Not connected
 (Blinking white)	Connecting
 (White)	Connected
 (Animated)	Transfer in progress
	Interrupted
	Error acquiring Eye-Fi card information (Restart the camera. Repeated display of this icon may indicate a problem with the card.)

Images labeled with a  icon have been transferred.





- Power saving (p. 36) on the camera is temporarily disabled during image transfer.
- Choosing  mode will interrupt the Eye-Fi connection. Although the Eye-Fi connection will be restored after you choose another shooting mode or enter Playback mode, the camera may transfer any movies made in  mode again.

## Checking Connection Information

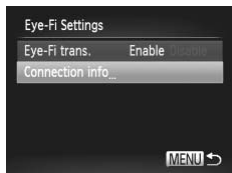
Check the access point SSID used by the Eye-Fi card or the connection status, as needed.





- Press the **MENU** button, choose [Eye-Fi Settings] on the  tab, and then press the  button.
- Choose [Connection info], and then press the  button.
- ▶ The connection information screen is displayed.

## Disabling Eye-Fi Transfer

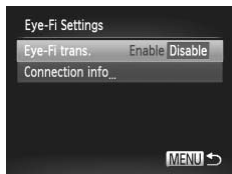
Configure the setting as follows to disable Eye-Fi transfer by the card, if necessary.



### Choose [Disable] in [Eye-Fi trans.].

- Press the **MENU** button, choose [Eye-Fi Settings] on the  tab, and then press the  button.
- Choose [Eye-Fi trans.], and then choose [Disable].



- [Eye-Fi Settings] is not shown unless an Eye-Fi card is in the camera with its write-protect tab in the unlocked position. For this reason, you cannot change settings for an inserted Eye-Fi card if the write-protect tab is in the locked position.



# 9

## Appendix

| Helpful information when using the camera

# Troubleshooting

If you think there is a problem with the camera, first check the following. If the items below do not solve your problem, contact a Canon Customer Support Help Desk.

---

## Power

### Nothing happens when the power button is pressed.

- Confirm that you are using the correct type of battery, and that there is sufficient charge (p. 223).
- Confirm that the battery is inserted facing the correct way (p. 15).
- Confirm that the memory card/battery cover is fully closed (p. 16).
- Dirty battery terminals reduce battery performance. Try cleaning the terminals with a cotton swab and reinserting the battery a few times.

### The battery is depleted quickly.

- Battery performance decreases at low temperatures. Try warming the battery a little by putting it in your pocket, for example, with the terminal cover on.
- If these measures do not help and the battery is still depleted soon after charging, it has reached the end of its life. Purchase a new battery.

### The lens is not retracted.

- Do not open the memory card/battery cover while the camera is on. Close the cover, turn the camera on, and then turn it off again (p. 16).

### The battery is swollen.

- Battery swelling is normal and does not pose any safety concerns. However, if battery swelling prevents the battery from fitting in the camera, contact a Canon Customer Support Help Desk.

---

## Display on a TV

Camera images look distorted or not displayed on a TV (p. 187).

---

## Shooting

### Cannot shoot.

- In Playback mode (p. 20), press the shutter button halfway (p. 37).

### Nothing is displayed (p. 46).

### Strange display on the screen under low light (p. 39).

### Strange display on the screen when shooting.

Note that the following display problems are not recorded in still images but are recorded in movies.

- The screen may flicker and horizontal banding may appear under fluorescent or LED lighting.



**⚡ flashes on the screen when the shutter button is pressed, and shooting is not possible (p. 47).**

**📷 is displayed when the shutter button is pressed halfway (p. 46).**

- Set [IS mode] to [Continuous] (p. 120).
- Raise the flash and set the flash mode to ⚡ (p. 116).
- Increase the ISO speed (p. 95).
- Mount the camera on a tripod or take other measures to keep it still. In this case, set [IS Mode] to [Off] (p. 120).

**Shots are out of focus.**

- Press the shutter button halfway to focus on subjects before pressing it all the way down to shoot (p. 37).
- Make sure subjects are within focusing range (see “Specifications” in the *Getting Started* guide).
- Set [AF-assist Beam] to [On] (p. 65).
- Confirm that unneeded functions such as macro are deactivated.
- Try shooting with focus lock or AF lock (pp. 109, 114).

**No AF frames are displayed and the camera does not focus when the shutter button is pressed halfway.**

- To have AF frames displayed and the camera focus correctly, try composing the shot with higher-contrast subject areas centered before you press the shutter button halfway. Otherwise, try pressing the shutter button halfway repeatedly.

**Subjects in shots look too dark.**

- Raise the flash and set the flash mode to ⚡ (p. 116).
- Adjust brightness by using exposure compensation (p. 93).
- Adjust contrast by using i-Contrast (pp. 98, 163).
- Use spot metering or AE lock (pp. 93, 94).

**Subjects look too bright, highlights are washed-out.**

- Lower the flash and set the flash mode to 📷 (p. 45).
- Adjust brightness by using exposure compensation (p. 93).
- Use spot metering or AE lock (pp. 93, 94).
- Reduce the lighting on subjects.

**Shots look too dark despite the flash firing (p. 46).**

- Shoot within flash range (p. 116).
- Adjust brightness by using flash exposure compensation or changing the flash output level (pp. 117, 127).
- Increase the ISO speed (p. 95).

**Subjects in flash shots look too bright, highlights are washed-out.**

- Shoot within flash range (p. 116).
- Lower the flash and set the flash mode to 📷 (p. 45).
- Adjust brightness by using flash exposure compensation or changing the flash output level (pp. 117, 127).

**White dots or similar image artifacts appear in flash shots.**

- This is caused by light from the flash reflecting off dust or airborne particles.

### Shots look grainy.

- Lower the ISO speed (p. 95).
- High ISO speeds in some shooting modes may cause grainy images (p. 70).

### Subjects are affected by red-eye (p. 58).

- Set [Red-Eye Lamp] to [On] (p. 65) to activate the red-eye reduction lamp (p. 4) in flash shots. For best results, have subjects look at the red-eye reduction lamp. Also try increasing the lighting in indoor scenes and shooting at closer range.
- Edit images using red-eye correction (p. 164).

### Recording to the memory card takes too long, or continuous shooting is slower.

- Use the camera to perform low-level formatting of the memory card (p. 172).

### Shooting settings or FUNC. menu settings are not available.

- Available setting items vary by shooting mode. Refer to “Functions Available in Each Shooting Mode”, “FUNC. Menu”, and “Shooting Menu” (pp. 226 – 233).

---

## Shooting Movies

### Cannot shoot movies (p. 17).

#### The elapsed time shown is incorrect, or recording is interrupted.

- Use the camera to format the memory card, or switch to a card that supports high-speed recording. Note that even if the elapsed time display is incorrect, the length of movies on the memory card corresponds to the actual recording time (p. 171).

#### is displayed and shooting stops automatically.

The camera's internal memory buffer filled up as the camera could not record to the memory card quickly enough. Try one of the following measures.

- Use the camera to perform low-level formatting of the memory card (p. 172).
- Lower the image quality (p. 60).
- Switch to a memory card that supports high-speed recording (see “Specifications” in the *Getting Started* guide).

#### Zooming is not possible.

- Zooming is not possible when shooting movies in modes that do not support digital zoom.
- Zooming is not possible when shooting movies in  mode.

#### Subjects look distorted.

- Subjects that pass in front of the camera quickly may look distorted. This is not a malfunction.

---

## Playback

### Playback is not possible.

- Image or movie playback may not be possible if a computer is used to rename files or alter the folder structure. Refer to the *Software Guide* for details on folder structure and file names.







**Playback stops, or audio skips.**

- Switch to a memory card that you have performed low-level formatting on with the camera (p. 172).
- There may be brief interruptions when playing movies copied to memory cards that have slow read speeds.
- When movies are played on a computer, frames may be dropped and audio may skip if computer performance is inadequate.

---

**Computer****Cannot transfer images to a computer.**

When attempting to transfer images to the computer via a cable, try reducing the transfer speed as follows.

- Press the  button to enter Playback mode. Hold the **MENU** button down as you press the  and  buttons at the same time. On the next screen, press the   buttons to choose [B], and then press the  button.

---

**Eye-Fi Cards**

Cannot transfer images (p. 212).

# On-Screen Messages

If an error message is displayed, respond as follows.

---

## No memory card

- The memory card may be inserted facing the wrong way. Reinsert the memory card facing the correct way (p. 16).

---

## Memory card locked

- The write-protect tab of the SD/SDHC/SDXC memory card or Eye-Fi card is set to the locked position. Switch the write-protect tab to the unlocked position (p. 15).

---

## Cannot record!

- Shooting was attempted without a memory card in the camera. To shoot, insert a memory card facing the correct way (p. 16).

---

## Memory card error (p. 172)

- If the same error message is displayed even when you have inserted a formatted memory card facing the correct way, contact a Canon Customer Support Help Desk (p. 16).

---

## Insufficient space on card

- There is not enough free space on the memory card to shoot (pp. 43, 67, 91, 123) or edit images (pp. 160 – 164). Either erase unneeded images (pp. 152) or insert a memory card with enough free space (see “Specifications” in the *Getting Started* guide).

---

## Change the battery pack. (p. 15)

---

## No Image.

- The memory card does not contain any images that can be displayed.

---

## Protected! (p. 148)

---

## Unidentified Image/Incompatible JPEG/Image too large./Cannot play back AVI/RAW

- Unsupported or corrupt images cannot be displayed.
- It may not be possible to display images that were edited or renamed on a computer, or images shot with another camera.

---

## Cannot magnify!/Cannot play back this content in Smart Shuffle/Cannot rotate/Cannot modify image/Cannot register this image!/Cannot modify/ Cannot assign to category/Unselectable image.

- The following functions may be unavailable for images that were renamed or already edited on a computer, or images shot with another camera. Note that starred (\*) functions are not available for movies.  
Magnify\* (p. 145), Smart Shuffle\* (p. 147), Categorize (p. 157), Rotate (p. 155), Edit\* (pp. 160 – 164), Assign as Start-up Image\* (p. 171), and Print Order\* (p. 208).
- Grouped images cannot be processed (p. 85).

---

## Invalid selection range

- When specifying a range for image selection (pp. 150, 153, 159, 210), you attempted to choose an initial image that was after the final image, or vice-versa.

---

**Exceeded selection limit**

- More than 998 images were selected for Print Order (p. 208). Choose 998 images or less.
- Print Order (p. 208) settings could not be saved correctly. Reduce the number of selected images and try again.
- You attempted to choose more than 500 images in Protect (p. 148), Erase (p. 152), Favorites (p. 157), My Category (p. 158), or Print Order (p. 208).

---

**Communication error**

- An excessive amount of images (approx. 1,000) on the memory card prevented printing or image transfer to a computer. To transfer the images, use a commercially available USB card reader. To print, insert the memory card directly into the printer card slot.

---

**Naming error!**

- When the highest folder number (999), and the highest image number (9999) has been reached, new folders cannot be created, and images cannot be recorded. In the **↑↑** menu, change [File Numbering] to [Auto Reset] (p. 173), or format the memory card (p. 171).

---

**Lens Error**

- This error may occur if the lens is held while it is moving, or when the camera is used in dusty or sandy locations.
- Frequent display of this error message may indicate camera damage. In this case, contact a Canon Customer Support Help Desk.

---

**A camera error was detected (error number)**

- If this error message is displayed immediately after a shot, the image may not have been saved. Switch to Playback mode to check for the image.
- Frequent display of this error message may indicate camera damage. In this case, write down the error number (Exx) and contact a Canon Customer Support Help Desk.

---

**File Error**

- It may not be possible to print computer-edited images or images shot with another camera.

---

**Print error**



- Check the paper size setting. If this error message is displayed when the setting is correct, restart the printer and complete the setting on the camera again.

---

**Ink absorber full**

- Contact a Canon Customer Support Help Desk to request assistance with ink absorber replacement.





\*  : Regular orientation,   : Held vertically

The camera detects the shooting orientation and adjusts settings for optimal shots. Orientation is also detected during playback, and in either orientation, the camera automatically rotates images as needed.

However, the orientation may not be detected correctly when the camera is pointed straight up or down.

## **Battery Level**

An on-screen icon or message indicates the battery charge level.

Display	Details
	Sufficient charge
	Slightly depleted, but sufficient
 (Blinking red)	Nearly depleted—charge the battery soon
[Change the battery pack.]	Depleted—charge the battery immediately

## Playback (Detailed Information Display)

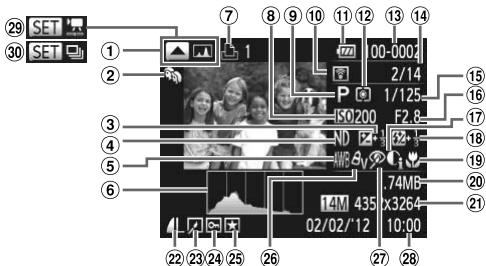















- |  |  |  |
|--|--|--|
| ① Switch display (RGB histogram) (p. 139)  | ⑪ Battery level (p. 223)   | ⑳ File size  |
| ② My Category (p. 158)   | ⑫ Metering method (p. 94)  | ㉑ Still images: Resolution<br>Movies: Movie length                                     |
| ③ Exposure compensation level (p. 93), Exposure shift level (p. 88)                          | ⑬ Folder number - File number (p. 173)   | ㉒ Compression (image quality) (p. 58) / Resolution (p. 57), RAW (p. 119), MOV (movies) |
| ④ ND filter (p. 99)  | ⑭ Current image no. / Total no. of images  | ㉓ Group playback (p. 144), Image editing (pp. 160 – 164)                               |
| ⑤ White balance (p. 100), White balance correction (p. 101), Mercury lamp correction (p. 59) | ⑮ Shutter speed (still images) (p. 124), Image quality / Frame rate (movies) (p. 60) | ㉔ Protection (p. 148)  |
| ⑥ Histogram (p. 138)   | ⑯ Aperture value (pp. 125, 126)  | ㉕ Favorite (p. 157)  |
| ⑦ Print order (p. 208)   | ⑰ i-Contrast (pp. 98, 163)   | ㉖ My Colors (pp. 102, 162)   |
| ⑧ ISO speed (p. 95), Playback speed (p. 75)  | ⑱ Flash (p. 116), Flash exposure compensation (p. 117)                               | ㉗ Red-eye correction (pp. 58, 164)   |
| ⑨ Shooting mode (p. 226)   | ㉒ Focusing range (pp. 105, 106)  | ㉘ Shooting date/time (p. 18)   |
| ⑩ Transferred via Eye-Fi (p. 212)  |  | ㉙ Movie (pp. 44, 136)  |
|  |  | ㉚ High-speed burst HQ (p. 85)  |



\* Some information may not be displayed when viewing images on a TV (p. 186).



## Summary of Movie Control Panel in “Viewing” (p. 136)

	Exit
	Play
	Slow Motion (To adjust the playback speed, press the ◀▶ buttons or turn the  dial. No sound is played.)
	Skip Backward* (To continue skipping backward, keep holding down the  button.)
	Previous Frame (For fast-rewind, keep holding down the  button.)
	Next Frame (For fast-forward, keep holding down the  button.)
	Skip Forward* (To continue skipping forward, keep holding down the  button.)
	Edit (p. 165)
	Shown when the camera is connected to a PictBridge-compatible printer (p. 202).

\* Displays the frame approx. 4 sec. before or after the current frame.



• To skip forward or back during movie playback, press the ◀▶ buttons.

# Functions and Menu Tables

## Functions Available in Each Shooting Mode

Function	Shooting Mode	SCN										
		C2	C1	M	Av	Tv	P	AUTO				
Exposure Compensation (p. 93)		+1	+1	—	○	○	○	—	○	○	○	○
ISO Speed (p. 95)		+1	+1	—	○	○	○	○	○	○	○	○
	—	+1	+1	○	○	○	○	—	○	—	—	—
White Balance Correction (p. 101)		+1	+1	○	○	○	○	—	—	—	—	—
Flash (p. 116)*3		+1	+1	—	—	—	○	○	○	○	○	○
		+1	+1	○	○	○	○	—	○	○	○	○
		+1	+1	—	○	—	○	*4	○	—	+5	—
		+1	+1	○	○	○	○	○	○	○	○	○
Metering Method (p. 94)		+1	+1	○	○	○	○	○	○	○	○	○
		+1	+1	○	○	○	○	—	○	—	—	—
Shutter Speed (p. 124)		+1	+1	○	—	○	—	—	—	—	—	—
Aperture Value (p. 125)		+1	+1	○	○	—	—	—	—	—	—	—
Program Shift (p. 93)		○	○	—	○	○	○	—	○	—	—	—
AE Lock (p. 93)/FE Lock (p. 118)		○	○	—	○	○	○	—	○	—	—	—
AE Lock (Movie)/Exposure Shift (p. 88)		—	—	—	—	—	—	—	—	—	—	—
AF Lock (when registered to the  button) (p. 131)		○	○	○	○	○	○	—	○	○	○	—
Focusing Range (pp. 105, 106)		+1	+1	○	○	○	○	○	○	○	○	○
		+1	+1	○	○	○	○	—	○	○	○	—
		+1	+1	○	○	○	○	—	○	○	○	—
Change AF Frame Position (p. 110)		+1	+1	○	○	○	○	—	—	—	—	—
Change AF Frame Size (p. 110)		+1	+1	○	○	○	○	—	○	○	○	○
Face Select (p. 113)		○	○	○	○	○	○	○	○	○	○	○
Tracking AF (pp. 55, 111)		○	○	○	○	○	○	○	—	○	○	○
Screen Display (p. 39)	Off	+1	+1	○	○	○	○	○	—	○	○	○
	Display 1	+1	+1	○	○	○	○	○	○	○	○	○
	Display 2	+1	+1	○	○	○	○	○	○	○	○	○

### FUNC. Menu

DR Correction (p. 98)		+1	+1	○	○	○	○	—	○	○	○	○
		+1	+1	—	○	○	○	○	—	—	—	—
		+1	+1	○	○	○	○	—	—	—	—	—
Shadow Correct (p. 99)		+1	+1	○	○	○	○	—	○	○	○	○
		+1	+1	○	○	○	○	○	○	—	—	—

\*1 The available settings depend on the registered shooting modes. \*2 Detailed settings not available.

\*3 Fixed to when the flash is lowered, but selectable when the flash is raised.



## Functions and Menu Tables





Function		Shooting Mode	C2	C1	M	Av	Tv	P	AUTO	SCN			
White Balance (p. 100)	AWB	*1 *1	○	○	○	○	○	○	○	○	○	○	○
		*1 *1	○	○	○	○	○	—	○	—	—	—	
		*1 *1	○	○	○	○	○	—	○	—	—	—	
		*1 *1	○	○	○	○	○	—	○	—	—	—	
My Colors (p. 102)	OFF	*1 *1	○	○	○	○	○	○	○	○	○	○	○
		*1 *1	○	○	○	○	○	—	○	—	—	—	
Bracketing (pp. 115, 97)		*1 *1	○	○	○	○	○	○	○	○	○	○	○
		*1 *1	—	○	○	○	○	—	—	—	—	—	
Drive Mode (p. 104)		*1 *1	○	○	○	○	○	○	○	○	○	○	○
		*1 *1	○	○	○	○	○	—	—	○	○	○	○
	*5	*1 *1	○	○	○	○	○	—	—	○	○	○	○
Self-Timer (p. 52)		*1 *1	○	○	○	○	○	○	○	○	○	○	○
		*1 *1	○	○	○	○	○	○	○	○	○	○	○
		*1 *1	○	○	○	○	○	○	○	○	○	○	○
Self-Timer Settings (p. 53)	Delay*6	*1 *1	○	○	○	○	○	○	○	○	○	○	○
	Shots*7	*1 *1	○	○	○	○	○	○	—	○	○	○	○
Flash Exposure Compensation (p. 117)		*1 *1	—	○	○	○	○	—	○	—	—	—	
Flash Output Level (p. 127)		*1 *1	○	○	○	○	—	—	—	—	—	—	
ND Filter (p. 99)	ND	*1 *1	○	○	○	○	○	—	○	—	—	—	
	NFR	*1 *1	○	○	○	○	○	○	○	○	○	○	
Still Image Aspect Ratio (p. 56)	16:9 3:2 4:3 1:1 4:5	*1 *1	○	○	○	○	○	○	—	○	○	○	
Image Type (p. 119)	JPEG	*1 *1	○	○	○	○	○	—	—	—	—	—	
Resolution (p. 57)	L	*1 *1	○	○	○	○	○	○	○	○	○	○	
Compression (p. 58)	M1 M2 S	*1 *1	○	○	○	○	○	○	○	○	○	○	
		*1 *1	○	○	○	○	○	○	○	○	○	○	
Movie Quality (p. 60)	1920	*1 *1	○	○	○	○	○	○	○	○	○	○	
	1280	*1 *1	○	○	○	○	○	○	○	○	○	○	
	640	*1 *1	○	○	○	○	○	○	○	○	○	○	

\*1 The available settings depend on the registered shooting modes. \*2 Not available in or .

\*3 White balance is not available. \*4 Set in a range of 1 – 5: contrast, sharpness, color saturation, red, green, blue, and skin tone. \*5 is set with , AF lock, or .



 **Shooting Menu**

Function		Shooting Mode							SCN					
		C2	C1	M	Av	Tv	P	AUTO						
AF Frame (p. 108)	Face AiAF	*1	*1	○	○	○	○	○	○	○	○	○	○	
	Tracking AF	*1	*1	○	○	○	○	*2	—	○	○	○	○	
	FlexiZone/Center*2	*1	*1	○	○	○	○	—	○	○	○	○	○	
Digital Zoom (pp. 51, 107)	Standard	*1	*1	○	○	○	○	○	○	○	○	○	○	
	Off	*1	*1	○	○	○	○	○	○	○	○	○	○	
	Digital Tele-converter 1.5x/1.9x	*1	*1	○	○	○	○	—	—	—	—	—	—	
AF-Point Zoom (p. 63)	On	*1	*1	○	○	○	○	○	—	○	○	○	—	
	Off	*1	*1	○	○	○	○	○	○	○	○	○	○	
Servo AF (p. 112)	On	*1	*1	○	○	○	○	—	—	○	○	○	○	
	Off*4	*1	*1	○	○	○	○	○	○	○	○	○	—	
Continuous AF (p. 113)	On	*1	*1	○	○	○	○	○	○	○	○	○	—	
	Off	*1	*1	○	○	○	○	—	—	○	○	○	○	
AF-assist Beam (p. 65)	On	*1	*1	○	○	○	○	○	○	○	○	○	○	
	Off	*1	*1	○	○	○	○	○	○	○	○	○	○	
MF-Point Zoom (p. 106)	On	*1	*1	○	○	○	○	—	—	○	○	○	—	
	Off	*1	*1	○	○	○	○	○	○	○	○	○	○	
Safety MF (p. 106)	On	*1	*1	○	○	○	○	—	○	○	○	○	—	
	Off	*1	*1	○	○	○	○	○	○	○	○	○	○	
Flash Control (pp. 58, 65, 117, 118, 127)	Flash Mode	Auto	*1	*1	—	○	○	○	○	○	○	○	○	○
		Manual	*1	*1	○	○	○	—	—	—	—	—	—	—
	Flash Exp. Comp		*1	*1	—	○	○	○	—	○	—	—	—	—
	Flash Output		*1	*1	○	○	○	—	—	—	—	—	—	—
	Shutter Sync.	1st-curtain	*1	*1	○	○	○	○	○	○	○	○	○	○
		2nd-curtain	*1	*1	○	○	○	○	—	○	—	—	—	—
	Red-Eye Corr.	On	*1	*1	○	○	○	○	○	○	○	○	○	○
		Off	*1	*1	○	○	○	○	○	○	○	○	○	○
	Red-Eye Lamp	On	*1	*1	○	○	○	○	○	○	○	○	○	○
		Off	*1	*1	○	○	○	○	○	○	○	○	○	○
	Safety FE	On	*1	*1	—	○	○	○	○	○	○	○	○	○
Off		*1	*1	○	○	○	○	—	○	—	—	—	—	
ISO Auto Settings (p. 95)	Max ISO Speed	*1	*1	—	○	○	○	—	○	—	—	—	—	
	Rate of Change	*1	*1	—	○	—	○	—	○	—	—	—	—	
High ISO NR (p. 96)	Low / Standard / High	*1	*1	○	○	○	○	—	—	—	—	—	—	



Function	Shooting Mode	C2	C1	M	Av	Tv	P	AUTO	SCN			
Hg Lamp Corr. (p. 59)	On/Off*	—	—	—	—	—	—	○	—	—	—	—
Spot AE Point (p. 94)	Center	*1	*1	○	○	○	○	—	○	—	—	—
	AF Point	*1	*1	○	○	○	○	—	—	—	—	—
Safety Shift (p. 125)	On	*1	*1	—	○	○	—	—	—	—	—	—
	Off	*1	*1	○	○	○	○	○	○	○	○	○
Wind Filter (p. 61)	On	*1	*1	○	○	○	○	○	○	○	○	○
	Off	*1	*1	○	○	○	○	○	○	○	○	○
Review (p. 66)	Off	*1	*1	○	○	○	○	○	○	○	○	○
	2 sec.	*1	*1	○	○	○	○	○	○	○	○	○
	3 – 10 sec.	*1	*1	○	○	○	○	○	○	○	○	○
	Hold	*1	*1	○	○	○	○	○	○	○	○	○
Review Info (p. 66)	Off	*1	*1	○	○	○	○	○	○	○	○	○
	Detailed	*1	*1	○	○	○	○	○	○	○	○	○
	Focus Check	*1	*1	○	○	○	○	○	○	○	○	○
Blink Detection (p. 64)	On	*1	*1	○	○	○	○	○	○	○	○	○
	Off	*1	*1	○	○	○	○	○	○	○	○	○
Custom Display (p. 128)	Shooting Info	*1	*1	○	○	○	○	○	○	○	○	○
	Grid Lines	*1	*1	○	○	○	○	○	○	○	○	○
	Electronic Level	*1	*1	○	○	○	○	○	○	○	○	○
	Histogram	*1	*1	○	○	○	○	○	○	○	○	○
Reverse Disp. (p. 17)	On	*1	*1	○	○	○	○	○	○	○	○	○
	Off	*1	*1	○	○	○	○	○	○	○	○	○
IS Settings (p. 120)	IS Mode	Off	*1	*1	○	○	○	○	○	○	○	○
		Continuous	*1	*1	○	○	○	○	○	○	○	○
		Shoot Only	*1	*1	○	○	○	○	—	○	○	○
	Powered IS	On	*1	*1	○	○	○	○	○	○	○	○
Off		*1	*1	○	○	○	○	○	○	○	○	
Date Stamp (p. 54)	Off	*1	*1	○	○	○	○	○	○	○	○	○
	Date	*1	*1	○	○	○	○	○	○	○	○	○
	Date & Time	*1	*1	○	○	○	○	○	○	○	○	○
Set   Func. (p. 129)		*1	*1	○	○	○	○	—	—	—	—	
Set Shortcut button (p. 131)		*1	*1	○	○	○	○	○	○	○	○	
Save Settings (p. 132)		○	○	○	○	○	○	—	—	—	—	

\*1 The available settings depend on the registered shooting modes. \*2 Only available by pressing the button (p. 108).

\*3 [FlexiZone] in **P**, **Tv**, **Av** and **M** modes, and [Center] in all other modes.





## ⚙️ Set up Menu

Item	Ref. Page
Mute	p. 168
Volume	p. 168
Sound Options	p. 169
Hints & Tips	p. 169
LCD Brightness	p. 170
Start-up Image	p. 170
Format	pp. 171, 172
File Numbering	p. 173
Create Folder	p. 173
Lens Retract	p. 174
Power Saving	pp. 36, 174

Item	Ref. Page
Time Zone	p. 175
Date/Time	p. 19
Distance Units	p. 176
Electronic Level	p. 176
Video System	p. 187
Ctrl via HDMI	p. 188
Eye-Fi Settings	p. 212
Copyright Info	p. 177
Language 	p. 20
Reset All	p. 179

## ★ My Menu Menu

Item	Ref. Page
My Menu settings	p. 133

 **Playback Menu**

Item	Ref. Page	Item	Ref. Page
Movie Digest Playback	p. 143	Red-Eye Correction	p. 164
Smart Shuffle	p. 147	Trimming	p. 161
Slideshow	p. 146	Resize	p. 160
Erase	p. 152	My Colors	p. 162
Protect	p. 148	Scroll Display	p. 137
Rotate	p. 155	Group Images	p. 144
Favorites	p. 157	Auto Rotate	p. 155
My Category	p. 158	Resume	p. 137
i-Contrast	p. 163	Transition	p. 137

 **Print Menu**

Item	Ref. Page	Item	Ref. Page
Print	—	Select All Images	p. 211
Select Images & Qty.	p. 210	Clear All Selections	p. 211
Select Range	p. 210	Print Settings	p. 209

## Handling Precautions

- The camera is a high-precision electronic device. Avoid dropping it or subjecting it to strong impact.
- Never bring the camera near magnets, motors, or other devices that generate strong electromagnetic fields, which may cause malfunction or erase image data.
- If water droplets or dirt adheres to the camera or screen, wipe with a dry soft cloth, such as an eyeglass cloth. Do not rub hard or apply force.
- Never use cleaners containing organic solvents to clean the camera or screen.
- Use a blower brush to remove dust from the lens. If cleaning is difficult, contact a Canon Customer Support Help Desk.
- To prevent condensation from forming on the camera after sudden temperature changes (when the camera is transferred from cold to warm environments), put the camera in an airtight, resealable plastic bag and let it gradually adjust to the temperature before removing it from the bag.
- If condensation does form on the camera, stop using it immediately. Continuing to use the camera in this state may damage it. Remove the battery and memory card, and wait until the moisture has evaporated before resuming use.

## A

AC adapter kit .....	189
Accessories .....	182
AEB mode .....	97
AE lock .....	93
AF frames .....	22, 45, 108, 110
AF → Focusing	
AF lock .....	114
Aspect ratio .....	56
AUTO mode (shooting mode) .....	21, 39, 44
Av (shooting mode) .....	125
AV cable .....	186

## B

Battery	
Charging .....	14
Level .....	223
Power saving .....	36
Black and white images .....	73, 102
Blink detection .....	64

## C

C1/C2 (shooting mode) .....	132
Camera	
Reset all .....	179
Camera shake .....	120
Clock .....	42
Color (white balance) .....	100
Color Accent (shooting mode) .....	78
Color Swap (shooting mode) .....	79
Compression ratio (image quality) .....	58
Continuous shooting .....	104
High-speed burst HQ (shooting mode) .....	85
Creative filters (shooting mode) .....	71
Cropping .....	161
Custom white balance .....	101

## D

Date/time	
Adding date/time to images .....	54
Changing .....	19
Setting .....	18
World clock .....	175
Defaults → Reset all	

DIGITAL CAMERA Solution Disk .....	2
Digital tele-converter .....	107
Digital zoom .....	51
Display language .....	20
DPOF .....	208
Drive mode .....	104
Dynamic Range Correction .....	98

## E

Editing	
Cropping .....	161
i-Contrast .....	163
My Colors .....	162
Red-eye correction .....	164
Resizing images .....	160
Erasing .....	152
Erasing all .....	152
Error messages .....	220
Exposure	
AE lock .....	93
Compensation .....	93
FE lock .....	118
Eye-Fi cards .....	2, 212

## F

Face AiAF (AF frame mode) .....	108
Face select .....	113
Face self-timer (shooting mode) .....	84
Favorites .....	157
FE lock .....	118
File numbering .....	173
Fireworks (shooting mode) .....	70
Fish-eye effect (shooting mode) .....	74
Flash	
Flash exposure compensation .....	117
On .....	116
Slow synchro .....	116
FlexiZone (AF frame mode) .....	109
Focus bracketing .....	115
Focus check .....	139
Focusing	
AF frames .....	108
AF lock .....	114
AF-point zoom .....	63
Face select .....	113

Servo AF.....	112
Focusing range	
Macro.....	105
Manual focus.....	106
Focus lock.....	109
FUNC. menu	
Basic operations.....	40

**H**

Handheld nightscene (shooting mode).....	69
High dynamic range (shooting mode).....	72
High-speed burst HQ (shooting mode).....	85
Household power.....	189

**I**

i-Contrast.....	98, 163
Image quality → Compression ratio	
Images	
Display period.....	66
Erasing.....	152
Playback → Viewing	
Protecting.....	148
Indicator.....	42
Interface cable.....	2, 29, 202
ISO speed.....	95

**L**

Lamp.....	65
Language display.....	20

**M**

M (shooting mode).....	126
Macro (focus mode).....	105
Magnified display.....	145
Manual focus (focus mode).....	106
Memory cards.....	2
Menu	
Basic operations.....	41
Table.....	226
Metering method.....	94
Miniature effect (shooting mode).....	74
Monochrome (shooting mode).....	77
Movie Digest (shooting mode).....	81
Movies	
Editing.....	165

Image quality (resolution/frame rate).....	60
Multi-area White Balance.....	59
My Category.....	158
My Colors.....	102, 162

**N**

ND filter.....	99
Nostalgic (shooting mode).....	73

**P**

P (shooting mode).....	92
Package Contents.....	2
PictBridge.....	185, 202
Playback → Viewing	
Portrait (shooting mode).....	68
Poster effect (shooting mode).....	71
Powered IS.....	121
Power → Battery, AC adapter kit	
Power saving.....	36
Printing.....	202
Program AE.....	92
Protecting.....	148

**R**

RAW.....	119
Red-eye correction.....	58, 164
Reset all.....	179
Resizing images.....	160
Resolution (image size).....	57
Rotating.....	155

**S**

Screen	
Icons.....	222, 224
Language display.....	20
Menu → FUNC. menu, Menu	
SD/SDHC/SDXC memory cards → Memory cards	
Self-timer.....	52
2-second self-timer.....	53
Customizing the self-timer.....	53
Face self-timer (shooting mode).....	84
Wink self-timer (shooting mode).....	83
Sepia tone images.....	73, 102
Servo AF.....	112

- Shadow Correct ..... 99
  - Shooting
    - Shooting date/time → Date/time
    - Shooting information ..... 128, 222
  - Slideshow ..... 146
  - Smart Shuffle ..... 147
  - Smart Shutter (shooting mode) ..... 82
  - Smile (shooting mode) ..... 82
  - Snow (shooting mode) ..... 70
  - Software
    - DIGITAL CAMERA Solution Disk ..... 2
    - Installation ..... 28
  - Sounds ..... 168
  - Sports (shooting mode) ..... 69
  - Stereo AV cable ..... 186
  - Stitch Assist (shooting mode) ..... 87
  - Super vivid (shooting mode) ..... 71
- T**
- Terminal ..... 29, 186, 187, 189, 202
  - Toy camera effect (shooting mode) ..... 76
  - Tracking AF ..... 55, 111
  - Traveling with the camera ..... 175, 182
  - Troubleshooting ..... 216
  - Tv (shooting mode) ..... 124
  - TV display ..... 186
- U**
- Underwater (shooting mode) ..... 69
- V**
- Viewfinder ..... 38
  - Viewing
    - Filtered playback ..... 141
    - Index display ..... 141
    - Magnified display ..... 145
    - Single-image display ..... 24
    - Slideshow ..... 146
    - Smart Shuffle ..... 147
    - TV display ..... 186
- W**
- White balance (color) ..... 100
  - Widescreen (resolution) ..... 57
  - Wink self-timer (shooting mode) ..... 83
  - World clock ..... 175
- Z**
- Zoom ..... 21, 44, 51

### **FCC Notice**

(Digital Camera, Model PC1674 systems)

This device complies with Part 15 of the FCC Rules. Operation is subject to the following two conditions;

- (1) this device may not cause harmful interference, and
- (2) this device must accept any interference received, including interference that may cause undesired operation.

Note: This equipment has been tested and found to comply with the limits for Class B digital devices, pursuant to Part 15 of the FCC rules. These limits are designed to provide reasonable protection against harmful interference in a residential installation. This equipment generates, uses and can radiate radio frequency energy and, if not installed and used in accordance with the instructions, may cause harmful interference to radio communications. However, there is no guarantee that interference will not occur in a particular installation. If this equipment does cause harmful interference to radio or television reception, which can be determined by turning the equipment off and on, the user is encouraged to try to correct the interference by one or more of the following measures:

- Reorient or relocate the receiving antenna.
- Increase the separation between the equipment and receiver.
- Connect the equipment into an outlet on a circuit different from that to which the receiver is connected.
- Consult the dealer or an experienced radio/TV technician for help.

The cable with the ferrite core provided with the digital camera must be used with this equipment in order to comply with Class B limits in Subpart B of Part 15 of the FCC rules.

Do not make any changes or modifications to the equipment unless otherwise specified in the manual. If such changes or modifications should be made, you could be required to stop operation of the equipment.

Canon U.S.A., Inc.

One Canon Plaza, Lake Success, NY 11042, U.S.A.

Tel No. (516) 328-5600

## **Canadian Radio Interference Regulations**

This Class B digital apparatus complies with Canadian ICES-003.

To ensure proper operation of this product, use of genuine Canon accessories is recommended.



### **USA and Canada only:**

The Lithium ion/polymer battery that powers the product is recyclable.

Please call 1-800-8-BATTERY for information on how to recycle this battery.



**For CA, USA only**

Included lithium battery contains Perchlorate Material - special handling may apply.

See [www.dtsc.ca.gov/hazardouswaste/perchlorate/](http://www.dtsc.ca.gov/hazardouswaste/perchlorate/) for details.

**Battery Charger CB-2LC**

**IMPORTANT SAFETY INSTRUCTIONS-SAVE THESE INSTRUCTIONS.**

**DANGER-TO REDUCE THE RISK OF FIRE OR ELECTRIC SHOCK, CAREFULLY FOLLOW THESE INSTRUCTIONS.**

For connection to a supply not in the U.S.A., use an attachment plug adapter of the proper configuration for the power outlet, if needed.

**Battery Charger CB-2LCE**

The adapter can be used with a power supply between 100 and 240 V AC. Contact your Canon dealer for information about plug adapter for overseas use.

For U.S.A. customers only: For areas where 120 V AC power is not used, you will need a special plug adapter.

For only United States

Use a UL listed, 1.8-3m(6-10ft), Type SPT-2 or NTSPT-2, AWG no.18 power supply cord, rated for 125V 7A, with a non-polarized NEMA 1-15P plug rated for 125V 15A.

**Trademark Acknowledgments**

- The SDXC logo is a trademark of SD-3C, LLC.
- This device incorporates exFAT technology licensed from Microsoft.
- HDMI, the HDMI logo and High-Definition Multimedia Interface are trademarks or registered trademarks of HDMI Licensing LLC.
- The iFrame logo and the iFrame symbol are trademarks of Apple INC.

**About MPEG-4 Licensing**

This product is licensed under AT&T patents for the MPEG-4 standard and may be used for encoding MPEG-4 compliant video and/or decoding MPEG-4 compliant video that was encoded only (1) for a personal and non-commercial purpose or (2) by a video provider licensed under the AT&T patents to provide MPEG-4 compliant video.

No license is granted or implied for any other use for MPEG-4 standard.

\* Notice displayed in English as required.

## **Disclaimer**

- Reprinting, transmitting, or storing in a retrieval system any part of this guide without the permission of Canon is prohibited.
- Canon reserves the right to change the contents of this guide at any time without prior notice.
- Illustrations and screenshots in this guide may differ slightly from the actual equipment.
- The above items notwithstanding, Canon accepts no liability for damages due to mistaken operation of the products.